



**ARCHITECTURAL,  
ACOUSTIC,  
SMOKE & FIRE  
CONTAINMENT  
SYSTEMS**

FIRE  
CONTAINMENT  
SYSTEMS



# We've been designing and manufacturing high performance sealing systems for over 40 years.

And we're passionate about the products we make. Lorient has an international reputation for designing and manufacturing a wide range of innovative door sealing solutions for the containment of fire, smoke, sound and energy. We pride ourselves on offering products that are designed to save lives, preserve property and enhance quality of life. We recognise our responsibility to create well-designed products that will perform; products which are durable and reliable, and which genuinely improve the buildings they protect. By doing so, we can play our part in improving life safety and reducing building damage and loss.

Having had a presence in Australia since 1986 the Lorient brand is well established and respected. Operating out of our new premises in Melbourne VIC we are proud to offer our comprehensive range of architectural seals, high quality intumescent seals, medium temperature smoke seals and acoustic seals to the Australian and New Zealand markets.

We also have a number of operations around the world; in North America, Hong Kong, Europe, Singapore and Dubai with our Head Office in the UK; which means that we're able to deliver the right solutions locally to our customers throughout the world.

By keeping abreast of technical developments and changes to codes, regulations and standards across the continents, we can ensure we're always providing the highest level of expertise. A trusted source for advice concerning testing, new product development or actual manufacture. We are always willing to partner and assist.





# SEALING DOORS WORLDWIDE

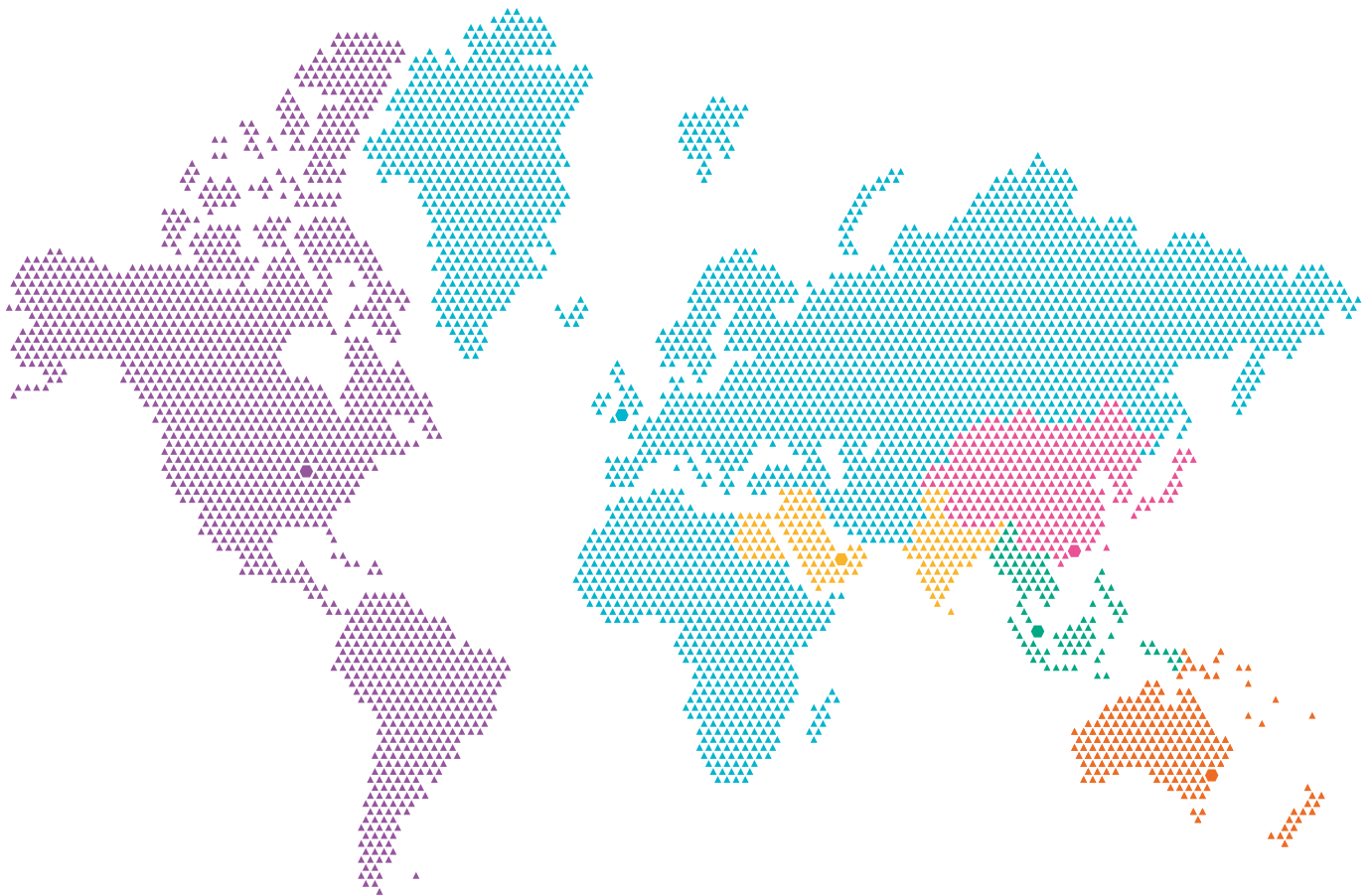

**The UK is home to our head office, manufacturing operation and dedicated R&D testing facility. Our UK & Europe head office supports operations around the world, delivering the best solutions locally to our customers across four continents.**

By keeping abreast of technical developments and changes to regulations and standards across the world, we deliver the highest levels of expertise and support.

 UNITED KINGDOM (HQ)

 AUSTRALIA

 SINGAPORE

 HONG KONG

 USA

 UAE

## CONTENTS

### ICONS EXPLAINED

The following icons are used throughout this brochure to give clear and easy recognition of a particular seal's function or possible application. Use of the icons does not necessarily indicate that test evidence exists. Please check with the Lorient Technical team.



Fire protection



Bush fire protection



Smoke protection



Hot smoke



Medium smoke



Acoustic protection



Weather protection



Light protection



Draught protection



Insect protection



Dust protection



Wheelchair friendly



Anti-microbial protection

### PRODUCT ILLUSTRATIONS

All dimensions in this brochure are in millimetres.

# INNOVATIVE DOOR SEALING SOLUTIONS

Lorient has an international reputation for designing and manufacturing a wide range of innovative door sealing solutions for the containment of fire, smoke, sound and energy.

## Lorient Architectural Seals

The Lorient Architectural Seals range incorporates a variety of complementary door sealing systems including perimeter seals, drop seals, threshold plates, door bottom seals plus much more. These seals can provide outstanding protection for all four sides of the door including sound, fire, smoke, light or energy and restrict unwanted nuisances such as drafts or insects.

Manufactured to the highest quality, Lorient Architectural Seals have been designed and tested for a host of different sectors including commercial, industrial and public buildings. Many of these sealing systems can easily be adjusted without the need to remove the door.

## Acoustic, Smoke + Fire Seals

Clearances around the four sides of a fire door leaf are essential – it's the only way the door can operate effectively. But these clearances create a point of weakness, which fire will readily exploit, if left un-sealed these gaps allow lethal smoke and hot gases to flow through unimpeded.

Our range of intumescent seals protect these clearances. In the event of fire the intumescent core expands 5-8 times its original size sealing the gap and providing an effective barrier to fire and hot smoke.

Our intumescent fire seals and combined acoustic, smoke and fire seals consist of intumescent material encased in rigid PVC which, for the combined seals also provides the carrier for an acoustic and smoke seal.

## AURA®

The AURA® range embraces a discerning selection of perimeter seals and threshold ramps – all with strong design accents. Every detail of the AURA® product range is considered and designed to integrate more successfully into beautifully designed doorsets and floors. A number of signature design details feature within the AURA® range; including a distinctive curved profile, which not only creates a sophisticated visual aesthetic, but also spreads and diffuses sound.

## Intumescent Fire Dampers

Air movement in a building is important. Stale air is bad for both the building and its occupants. Our intumescent grilles combine air movement with fire protection. In everyday use, air can pass freely through the grilles to allow good ventilation. In a fire, the intumescent expands, fusing the grille into a solid block that stops fire spreading.

A close-up photograph of a dark-colored door's hinge and lock mechanism. The hinge is a heavy-duty, multi-pin design with several screws. Below it, a lock mechanism is visible, featuring a brass-colored handle and a blue ring. The LORIENT logo, consisting of three wavy vertical lines and the brand name, is positioned in the upper right corner of the image.

 **LORIENT**

# STANDARDS + REGULATIONS

## Meeting the requirements

In Australia, building construction is regulated under a framework of provisions detailed within the National Construction Code and associated Building Code of Australia. These codes set out a uniform set of technical provisions that allow for the design and construction of buildings; they also make reference to a number of Australian and International standards to ensure that materials, systems, products and services provide a consistent and quantifiable performance level.

## Relevant Requirements

Fire and smoke protection measures are essential, lifesaving precautions in a building. What's more, they protect the property from the devastating consequences of the fire itself, and the damaging effects of hot and cold smoke. So it is essential to get the product selection right, every time.

Section C of the BCA details the fire protection requirements for building designs and is written to ensure safe evacuation of occupants and minimise the fire risk to adjoining property.

## Fire door assemblies

Fire resistant door assemblies are referenced in BCA Section C3 (specification C3.4.2) and are required to comply with Australian standard AS1905.1.

### ▶ AS1905.1 Components for the fire protection of openings in fire resistant walls Part 1: Fire doors

This standard specifies the construction and installation requirements for side hung, pivoted and sliding fire door assemblies. It provides detailed guidance on installation of door frames, as well as acceptable clearances allowed around the edges of the installed door leaf. This standard also outlines fire testing requirements for hardware fitted to the fire door and guidance on permissible variations. The fire resistance level (FRL) of a fire door and any constituent hardware is determined by fire testing a representative sample in accordance with AS1530.4.

### ▶ AS1530.4: 2014 Fire resistance tests of elements of building construction

This standard provides a fire test methodology and a set of exposure conditions that allows a building element's fire resistance level (FRL) to be determined. A FRL is designated according to the test element's ability to maintain its structural adequacy, integrity and its insulation values, and are expressed in this order.

The Lorient range of Architectural door sealing solutions have been extensively fire tested in accordance with AS1530.4 on most brands of fire door currently manufactured in Australia.

**Please refer to the "Specification of Fire Rated Door Hardware" section at [www.lorient.com.au](http://www.lorient.com.au) for a full listing of approvals, fire resistance rating and applicable door types.**



# SMOKE DOORS

When fire breaks out in a building the risk to life safety is two-fold. Firstly there is the fire itself & the buoyant hot smoke generated in the immediate vicinity. Then there is the cooler smoke & toxic gases which, if unimpeded will rapidly spread through the building, threatening people and property some distance from the fire.

Smoke doors provide a physical barrier that restricts the spread of smoke, assisting the occupants evacuation by ensuring egress routes remain clear and tenable.

## Smoke control door assemblies - Deemed To Satisfy Construction (DTS)

Smoke doors are referenced by the BCA in section C, Specification C3.4. This section outlines the general scope and requires that a smoke door must be constructed so that smoke will not pass from one side to the other and if it's glazed there is minimal danger of a person being injured by accidentally walking into them. The clause also provides a deemed to satisfy construction as follows;

- (a) The leaves are side-hung and swing
  - (i) in the direction of egress; or
  - (ii) in both directions.
- (b)(i) The leaves are capable of resisting smoke at 200°C for 30 minutes.
- (ii) Solid-core leaves\* at least 35mm thick satisfy (i).
- (c) The door leaves are fitted with smoke seals.
- (d)(i) The leaves are normally in the closed position; or
- (a) The leaves are closed automatically with the automatic closing operation initiated by smoke detectors, installed in accordance with the relevant provisions of AS 1670.1, located on each side of the doorway not more than 1.5m horizontal distance from the doorway; and (b) In the event of power failure to the door, the leaves fail-safe in the closed position.

- (e) The leaves return to the fully closed position after each manual opening.
- (f) Any glazing incorporated in the door complies with AS 1288.
- (g) (i) If a glazed panel is capable of being mistaken for an unobstructed exit, the presence of the glass must be identified by opaque construction.
- (ii) An opaque mid-height band, mid-rail or crash bar satisfies (i).

## Fire engineered smoke door specifications (performance-based)

The BCA permits the use of "Performance Based Alternative Solutions" and Fire Engineers now frequently reference two Australian Standards to create a comprehensive specification that details maximum leakage requirements for a complete door assembly and a test methodology that allows actual leakage rates to be determined. The two standards that are commonly referenced are: AS6905:2007 and AS1530.7:2007.

### ▶ AS6905:2007 - Smoke doors

This standard outlines the construction, installation and identification requirements for a complete smoke door assembly. Importantly this standard also provides guidance on the maximum acceptable leakage rates for both single and double leaf door assemblies. Smoke leakage rates are determined by subjecting a door assembly to the test method detailed AS1530.7.

### ▶ AS1530.7:2007 - Methods for fire tests on building materials, components and structures. Part 7 - Smoke control assemblies - ambient and medium temperature leakage test procedure

This standard provides a methodology to measure and quantify the leakage of both ambient and medium temperature air through a door assembly. The test procedure involves mounting a door into a sealed chamber and heating the air within to a temperature of 200°C and maintaining this for a period of 30 minutes. At various stages pressures are induced within the chamber and the corresponding leakage measurement logged and reported.

# ACOUSTICS FOR DOOR ASSEMBLIES

Door assemblies are an integral part of buildings and while there must be gaps around the perimeter of doors for them to operate efficiently, these gaps allow sound to pass freely.

## Acoustic regulations

Section F the Building Code of Australia (BCA) covers Sound Transmission within buildings and includes a set of construction and performance requirements to ensure occupants do not suffer illness or loss of amenity as a result of unwanted sound transmission.

## Acoustic provisions

The provisions outlined in Section F relate to certain building classifications and these include:

- ▶ **Class 2: Multi residential / sole occupancy apartment buildings**
- ▶ **Class 3: Hotels, Motels and Boarding houses**
- ▶ **Class 9C: Aged care facilities.**

Section F5.5.b requires a door assembly incorporated into a wall in a Class 2 or 3 building separating a sole occupancy unit from a stairway, corridor or public space to have an acoustic performance of not less than **30R<sub>w</sub>** - when determined by acoustic standards AS/NZS1276.1 or AS/ ISO717.1.

## Test method + expression of results

The AS1191 or ISO 10140.2 (formerly ISO 140.3) acoustic test method involves placing a representative door construction within a dividing wall between a reverberant "Source Room" and "Receiving Room". Sound waves are produced by a loudspeaker in the Source Room and microphones are used to obtain an average of the sound pressure levels within each room in the frequency range 100 to 5000 Hertz (Hz). From these laboratory measurements, the Sound Reduction Index (R) is derived by calculating the recorded results in accordance with AS/NZS ISO 717.1. The output is plotted as a curve at one-third octave intervals between 100Hz & 3150Hz and this final weighted sound reduction index value is expressed as R<sub>w</sub>.

## Acoustic sealing efficiency

It should be noted that Lorient sealing systems are acoustically tested full size in their normal everyday operational mode under laboratory conditions.

To evaluate the acoustic efficiency Lorient conduct a series of three tests which include:

- ▶ An initial test with the door in a unsealed condition (known as un-caulked), this provides the minimum level of performance the door can achieve with no seals.
- ▶ The same door is fitted with a sealing arrangement and re-tested to determine performance improvement.
- ▶ The door perimeter is sealed with a high density acoustic putty and re-tested to ascertain much sound is actually passing through the door leaf - (this final test reveals the maximum potential performance that the door can achieve).

By comparing these three results it is possible to determine the sealing system efficiency and maximum potential performance of the door assembly under evaluation.

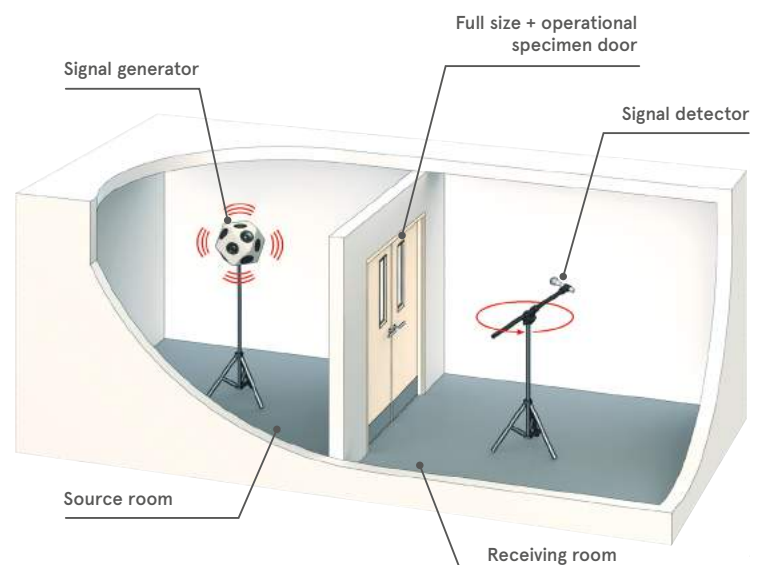

# EFFECTIVE ACOUSTIC SEALING SELECTION

Wherever noise influences human activity, effective acoustic sealing is essential. Whether preserving the confidentiality of discussions in a private office or doctor's surgery, or reducing noise from adjacent rooms in hotels; preservation of privacy is paramount.

## Relevant standards

The following standards relate to the testing and evaluation of acoustic doors:

**ISO 10140.2: 2021** (formerly ISO 10140.2: 2010): Methods of measurement of sound insulation in buildings and of building elements. Laboratory measurement of airborne sound insulation of building elements.

**AS1191 AS 1191-2002** - Acoustics - Laboratory measurement of airborne sound transmission insulation of building elements.

**AS/NZS ISO 717-1: 1997**: Rating of sound insulation in buildings and of building elements. Part 1 Airborne sound insulation.

## On-site considerations

The sound reduction performance of any system will vary according to the incident frequency of the sound waves to which it is exposed and whilst laboratory tests provide a standardised data of comparison, they should not be relied upon as a guarantee of performance of on-site installations.

Factors such as flanking paths, wall, floor and ceiling construction, room volumes and surface finishes all have a significant influence on acoustic performance.

Furthermore it should be noted that quality of workmanship relating to the installation and fitting of seals can also greatly influence final acoustic efficiency.

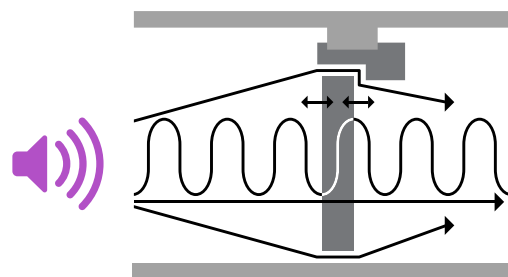

Sound passing through and around a door assembly









**AIR TRANSFER GRILLES**  
(PAGES 67–68)

---

**PRODUCT ILLUSTRATIONS**  
All dimensions in this brochure are in millimetres.  
**Please note** illustrations are not to scale and are for reference only.



# PERIMETER SEALS

A comprehensive range of slimline perimeter seals for installation around the head, jambs and meeting stiles of doors.

These seals are designed to accommodate a wide range of gap sizes and applications, and are ideally teamed with drop seals or door bottom seals.

## PERIMETER SEALS

# LAS1212 & LAS1515 Batwing®

## MEDIUM DUTY

The Lorient Batwing® series is primarily designed to contain sound and restrict the spread of medium temperature smoke around hinged door assemblies. Their symmetrical design and unique curved sealing fins provide outstanding performance benefits.

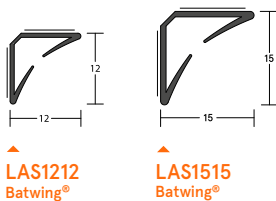

LAS1212  
Batwing®

LAS1515  
Batwing®



LAS1212 Batwing® shown  
with LAS8001 si drop seal

PERIMETER SEALS

## SYSTEM SPECIFICATIONS

### Key benefits

- ▶ Seals restrict the spread of medium temperature smoke (200°C).
- ▶ Highly effective acoustic seal that can be retrofitted to existing door assemblies.
- ▶ Low friction curved elastomeric fins spring back to original shape to provide continuous performance.
- ▶ Discreetly positioned in frame rebate to provide a fully concealed sealing solution. Simple peel-and-stick installation, our aggressive self-adhesive backing is tested on many surfaces to ensure seal longevity.
- ▶ Seal surface and fins contain anti-microbial additives to restrict bacterial growth.

### Gap sizes

- ▶ LAS1212 – 2-3mm.
- ▶ LAS1515 – 3mm.

### Approvals

- ▶ **Fire:** Tested in accordance with AS1530.4 on proprietary AS1905.1 fire door assemblies for up to 4 hour rating.
- ▶ **Smoke:** Tested in accordance with AS1530.7 with medium temperature smoke approvals for use on AS6905 compliant smoke door assemblies.
- ▶ **Sound:** Acoustically tested in accordance with ISO10140-2 and AS/NZS717.1 with ratings up to 39Rw on appropriate rated assemblies.
- ▶ **Bushfire:** Approved for use on proprietary fire door assemblies for Bushfire attack levels of Flame Zone (FZ) classification or less.
- ▶ **Durability:** Long term mechanical test, completing 100,000 cycles without failure.

### Fixing method

- ▶ Aggressive film backed self-adhesive.

### Standard lengths

- ▶ 1m, 2.1m and 2.75m.
- ▶ 2.4m and 3.0m available for black finish only.
- ▶ Single doorset (SDS): (1 x 1m, 2 x 2.1m)
- ▶ Long Single doorset (LSDS): (1 x 1m, 2 x 2.75m)
- ▶ Double doorset (DDS): (3 x 2.1m)
- ▶ Long double doorset (LDDS): (1 x 2.1m, 2 x 2.75m).

### Finishes

- ▶ Standard colours: Black & clear.
- ▶ White, grey & brown available to special order.
- ▶ Note: clear Batwing® will not prevent light penetration.

## PERIMETER SEALS

# LAS1011 Firtree™

## MEDIUM DUTY

The Firtree™ seal comprises a barbed spine that incorporates two flexible sealing fins. It simply push-fits into a 3mm wide x 5mm deep groove to provide an effective acoustic seal.



PERIMETER SEALS



LAS1011  
Firtree™



LAS1011 Firtree™ shown fitted to door edge

## SYSTEM SPECIFICATIONS

### Key benefits

- ▶ Ideal for double swing door applications as seal allows bypass of pivot hardware.
- ▶ Simply push fits into a pre-prepared groove.
- ▶ Fins are co-extruded to spine for reliable long term durability.
- ▶ Seal surface and fins contain anti-microbial additives to restrict bacterial growth.

### Gap sizes

- ▶ 2mm - 3mm.

### Fixing method

- ▶ Friction fit into 3mm wide x 5mm deep groove.

### Approvals

- ▶ **Fire:** Tested in accordance with AS1530.4 on proprietary AS1905.1 fire door assemblies for up to 4 hour rating.
- ▶ **Smoke:** Conforms with BCA Specification C3.4 smoke sealing requirements.
- ▶ **Sound:** Acoustically tested in accordance with ISO10140-2 and AS/NZS717.1 with ratings up to 38Rw on appropriate rated assemblies.
- ▶ **Bushfire:** Approved for use on proprietary fire door assemblies for Bushfire attack levels of Flame Zone (FZ) classification or less.
- ▶ **Durability:** Long term mechanical test, completing 100,000 cycles without failure.

### Standard lengths

- ▶ 1m, 2.1m and 2.75m.

### Finishes

- ▶ Standard colour: Black with black fins.



## PERIMETER SEALS

# LAS7001 si

## MEDIUM DUTY

A slim-line, stop mounted compression seal incorporating an anodised aluminium carrier fitted with a fire rated silicone rubber gasket and non-shrink, click-fit cover strip. The seal is fitted to the head and jambs of the door frame to create an effective seal between the frame and the door face.

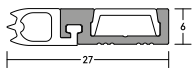

▲ LAS7001 si



▲ LAS7001 si

PERIMETER SEALS

## SYSTEM SPECIFICATIONS

### Key benefits

- ▶ A slim-line and unobtrusive acoustic seal that can easily be retrofitted to existing door assemblies.
- ▶ Fitted with high performance fire rated silicone rubber gasket.
- ▶ Supplied with slotted fixing holes for accurate positioning and easy adjustment.
- ▶ Non-shrink, click-fit cover strip conceals the fixing points.

### Gap sizes

- ▶ Accommodates and seals gaps from 0mm to 8mm.

### Fixing method

- ▶ Screw fixed to the door frame with supplied screw pack.

### Approvals

- ▶ **Fire:** Tested in accordance with AS1530.4 on proprietary AS1905.1 fire door assemblies for up to 4 hour rating.
- ▶ **Smoke:** Tested in accordance with AS1530.7 with medium temperature smoke approvals for use on AS6905 compliant smoke door assemblies.
- ▶ **Sound:** Acoustically tested in accordance with ISO10140-2 and AS/NZS717.1 with ratings up to 39Rw on appropriate rated assemblies.
- ▶ **Bushfire:** Approved for use on proprietary fire door assemblies for Bushfire attack levels of Flame Zone (FZ) classification or less.
- ▶ **Durability:** Long term mechanical test, completing 100,000 cycles without failure.

### Standard lengths

- ▶ 1m, 2.1m, 2.75m and 3m.
- ▶ Single doorset (SDS): (1 x 1m , 2 x 2.1m).
- ▶ Long Single doorset (LSDS): (1 x 1m, 2 x 2.75m).
- ▶ Double doorset (DDS): (3 x 2.1m).
- ▶ Long double doorset (LDDS): (1 x 2.1m, 2 x 2.75m).

### Finishes

- ▶ Silver anodised aluminium with grey silicone rubber gasket and click-fit cover strip.
- ▶ Special colours can be supplied using powder coated finish for additional aesthetics (lead times apply).

## PERIMETER SEALS

# LAS7003 si

## MEDIUM DUTY

A slim-line, stop mounted compression seal incorporating an anodised aluminium carrier fitted with an elliptical fire rated silicone rubber gasket and non-shrink, click-fit cover strip. The seal is fitted to the head and jambs of the door frame to create an effective seal between the frame and the door face.



PERIMETER SEALS

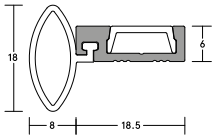

LAS7003 si



LAS7003 si shown fitted to door frame

## SYSTEM SPECIFICATIONS

### Key benefits

- ▶ Simple and effective acoustic seal that can easily be retrofitted to existing door assemblies.
- ▶ Slim-line and unobtrusive.
- ▶ Fitted with a smooth high performance fire rated silicone rubber gasket.
- ▶ Supplied with slotted fixing holes for accurate positioning and easy adjustment.
- ▶ Non-shrink, click-fit cover strip conceals the fixing points.

### Gap sizes

- ▶ Accommodates and seals gaps from 3mm to 7mm.

### Fixing method

- ▶ Screw fixed to the door frame with supplied screw pack.

### Approvals

- ▶ Tested in accordance with AS1530.4 on proprietary AS1905.1 fire door assemblies for up to 4 hour rating.
- ▶ **Sound:** Acoustically tested in accordance with ISO10140-2 and AS/NZS717.1 with ratings up to 40Rw on appropriate rated assemblies.
- ▶ **Bushfire:** Approved for use on proprietary fire door assemblies for Bushfire attack levels of Flame Zone (FZ) classification or less.
- ▶ **Durability:** Long term mechanical test, completing 100,000 cycles without failure.

### Standard lengths

- ▶ 1m, 2.1m and 3m.
- ▶ Single doorset (SDS): (1 x 1m, 2 x 2.1m).
- ▶ Other lengths to special order.

### Finishes

- ▶ Silver anodised aluminium with grey silicone rubber gasket and click-fit cover strip.

## PERIMETER SEALS

# LAS7004 si

## MEDIUM DUTY

Slimline, medium duty perimeter seal designed for or use around the perimeter and meeting stiles of single or double swing doors.

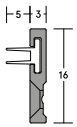

LAS7004 si



LAS7004 si shown fitted to meeting stiles

PERIMETER SEALS

## SYSTEM SPECIFICATIONS

### Key benefits

- ▶ Effective sealing solution for smoke, sound, light or weather.
- ▶ Acoustic data available in accordance with ISO10140.2.
- ▶ Durable silicone rubber finned gasket.
- ▶ Suitable to meet DTS smoke door specification C3.4.
- ▶ The leg of this seal can be cut out to accommodate lock hardware.
- ▶ May be surface mounted or semi mortised.

### Location

- ▶ Meeting stiles of single and double swing doors.
- ▶ Sliding doors.

### Approvals

- ▶ **Sound:** Acoustically tested in accordance with ISO10140-2 and AS/NZS717.1 with ratings up to 38Rw on appropriate rated assemblies.
- ▶ **Durability:** Tested for reliability, the seal completed 100,000 cycles without failure.

### Seal material

- ▶ Silicone rubber.
- ▶ Note: twin elastomeric fins will provide optimum acoustic performance.

### Fixing method

- ▶ Screw fixed to the door frame with supplied screw pack.

### Standard lengths

- ▶ 1m, 2.1m, 2.75m and 3m.
- ▶ Other lengths to special order.

### Finishes

- ▶ Silver anodised aluminium with grey twin fin silicone rubber insert.

## PERIMETER SEALS

# LAS7005 si

## MEDIUM DUTY

A robust stop mounted compression seal incorporating an anodised aluminium carrier fitted with fire rated silicone rubber gasket and non-shrink, click-fit cover strip. The seal is fitted to the head and jambs of the door frame to create an effective seal between the frame and the door face.



PERIMETER SEALS

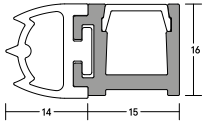

LAS7005 si



LAS7005 si shown fitted to door frame

## SYSTEM SPECIFICATIONS

### Key benefits

- ▶ Compact and effective acoustic seal that can easily be retrofitted to existing door assemblies.
- ▶ Fitted with high performance fire rated silicone rubber gasket.
- ▶ Supplied with slotted fixing holes for accurate positioning and easy adjustment.
- ▶ Non-shrink, click-fit cover strip conceals the fixing points.

### Gap sizes

- ▶ Accommodates and seals gaps from 0mm to 10mm.

### Fixing method

- ▶ Screw fixed to the door frame with supplied screw pack.

### Approvals

- ▶ **Fire:** Tested in accordance with AS1530.4 on proprietary AS1905.1 fire door assemblies for up to 4 hour rating.
- ▶ **Smoke:** Tested in accordance with AS1530.7 with medium temperature smoke approvals for use on AS6905 compliant smoke door assemblies.
- ▶ **Sound:** Acoustically tested in accordance with ISO10140-2 and AS/NZS717.1 with ratings up to 33Rw on appropriate rated assemblies.
- ▶ **Bushfire:** Approved for use on proprietary fire door assemblies for Bushfire attack levels of Flame Zone (FZ) classification or less.
- ▶ **Durability:** Long term mechanical test, completing 100,000 cycles without failure.

### Standard lengths

- ▶ 1m, 2.1m and 2.75m.
- ▶ Single doorset (SDS): (1 x 1m, 2 x 2.1m).
- ▶ Long Single doorset (LSDS): (1 x 1m, 2 x 2.75m).
- ▶ Double doorset (DDS): (3 x 2.1m).
- ▶ Long double doorset (LDDS): (1 x 2.1m, 2 x 2.75m).

### Finishes

- ▶ Silver anodised aluminium with grey silicone rubber gasket and click-fit cover strip.
- ▶ Special colours can be supplied using powder coated finish for additional aesthetics (lead times apply).

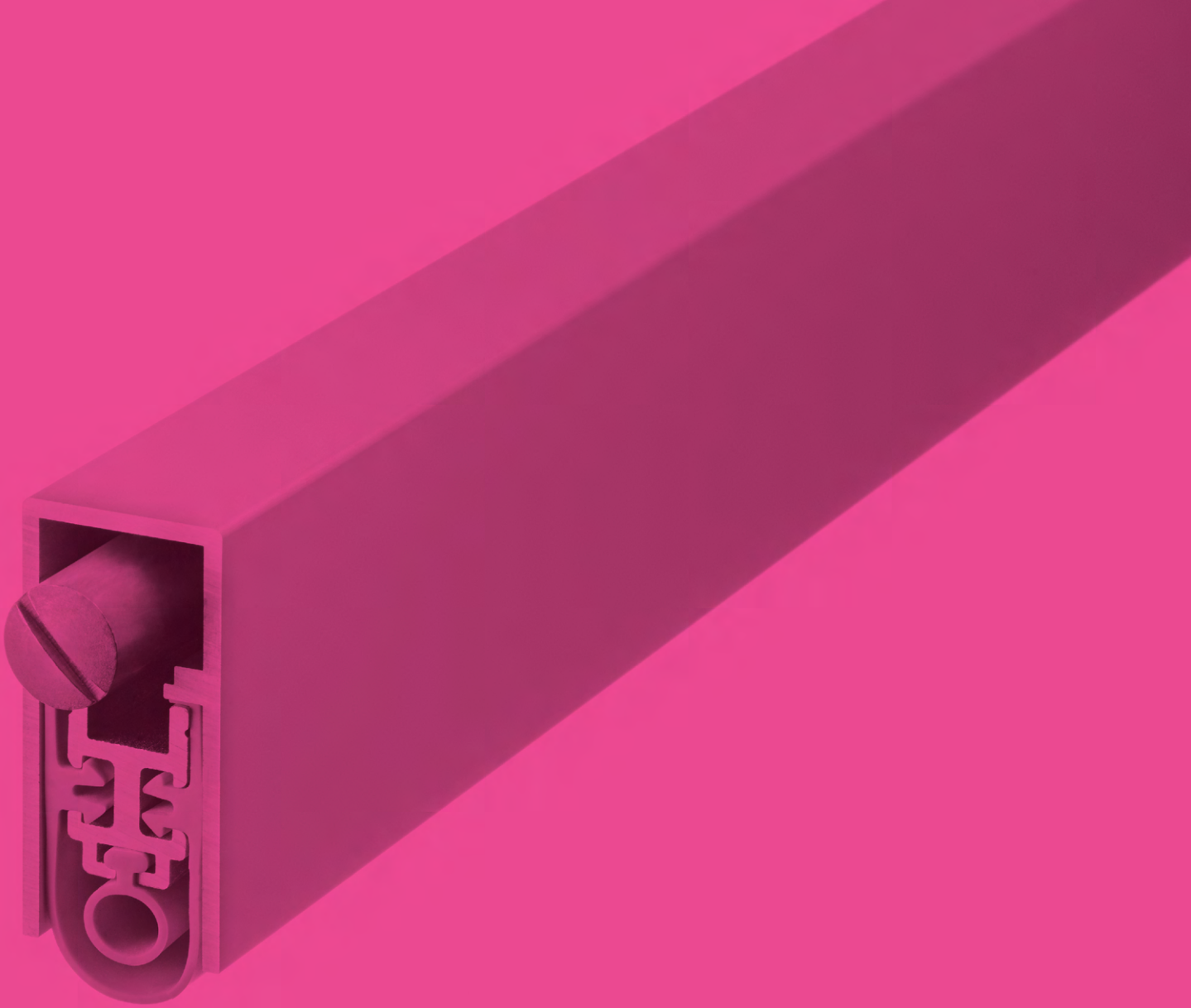

# DROP SEALS

A range of drop seals that fit to the bottom of a door and drop down automatically when the door closes to form a firm seal. Options include face-fixed installation, and semi or fully mortising into door leaves, for both medium and heavy duty applications.

A spring-loaded mechanism, requiring no power, ensures easy door operation and effective sealing when closed.



## DROP SEALS

# LAS8001 si

## HEAVY DUTY

This fully mortised aluminium automatic drop seal features a silicone rubber gasket and internal fins. It is used to close the gap under single swing doors to maintain their acoustic, smoke and energy efficiency performance. The seal incorporates a high efficiency spring loaded mechanism that extends the seal as the door swings shut and automatically retracts it as the door is opened by just a few centimetres.



DROP SEALS

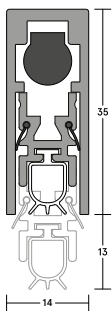

LAS8001 si



LAS8001 si

## SYSTEM SPECIFICATIONS

### Key benefits

- ▶ Effective acoustic sealing solution that is fully concealed in the bottom of the door.
- ▶ Dual internal sealing fins enhance acoustic and smoke containment performance.
- ▶ Supplied with high performance fire rated silicone rubber gasket.
- ▶ Fully automatic, no power connection required.
- ▶ Simple adjustment to suit varying door gap requirements.
- ▶ Proven long term reliability.

### Gap sizes

- ▶ Accommodates & seals gaps up to 13mm.
- ▶ Greater gaps can be sealed if product is used with a threshold plate, please speak to our technical team for more info.

### Approvals

- ▶ **Fire:** Tested in accordance with AS1530.4 on proprietary AS1905.1 fire door assemblies for up to 4 hour rating.
- ▶ **Smoke:** Tested in accordance with AS1530.7 with medium temperature smoke approvals for use on AS6905 compliant smoke door assemblies. Conforms with BCA Specification C3.4 smoke sealing requirements.
- ▶ **Sound:** Acoustically tested in accordance with ISO10140-2 and AS/NZS717.1 with ratings up to 42Rw on appropriate rated assemblies.
- ▶ **Bushfire:** Approved for use on proprietary fire door assemblies for Bushfire attack levels of Flame Zone (FZ) classification or less.
- ▶ **Durability:** Long term mechanical test, completing 100,000 cycles without failure.

### Fixing method

- ▶ Fits into a 15mm (W) x 35mm (D) groove fixed in place with screw fixed end plates.

### Standard lengths

- ▶ 435mm (may be cut back to 335mm)
- ▶ 535mm (may be cut back to 435mm)
- ▶ 635mm (may be cut back to 535mm)
- ▶ 735mm (may be cut back to 635mm)
- ▶ 820mm (may be cut back to 735mm)
- ▶ 920mm (may be cut back to 820mm)
- ▶ 1070mm (may be cut back to 920mm)
- ▶ 1220mm (may be cut back to 1070mm)
- ▶ 1400mm\* (may be cut back to 1220mm)
- ▶ 1600mm\* (may be cut back to 1400mm)

\*Non-standard sizes do not hold test evidence for the approval for use. Speak to our Technical Team for advice.

### Finishes

- ▶ Silver anodised aluminium with stainless steel end plates and grey silicone rubber gasket.

**Also available as a hot smoke seal** (LAS8001 si HSS) please refer to

## DROP SEALS

# LAS8002 si

## MEDIUM DUTY

This face-fixed (or semi-mortised) aluminium automatic drop seal features a silicone rubber gasket and internal fins. It is used to close the gap under single swing doors to maintain their acoustic, smoke and energy efficiency performance. The seal incorporates a high efficiency spring loaded mechanism that extends the seal as the door swings shut and automatically retracts it as the door is opened by just a few centimetres.

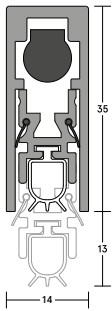

LAS8002 si



LAS8002 si

DROP SEALS

## SYSTEM SPECIFICATIONS

### Key benefits

- ▶ Effective acoustic sealing solution that can easily be retrofitted to existing door assemblies.
- ▶ Dual internal sealing fins enhance acoustic and smoke containment performance.
- ▶ Quick and easily installation.
- ▶ Can be fitted semi-mortised for a flush finish.
- ▶ Supplied with a fire rated silicone rubber gasket and aesthetic push-fit end caps.
- ▶ Fully automatic, no power connection required.
- ▶ Simple adjustment to suit varying door gap requirements.
- ▶ Proven long term reliability.

### Gap sizes

- ▶ Accommodates & seals gaps up to 13mm.
- ▶ Greater gaps can be sealed if product is used with a threshold plate; speak to our technical team for more info.

### Approvals

- ▶ **Fire:** Tested in accordance with AS1530.4 on proprietary AS1905.1 fire door assemblies for up to 4 hour rating.
- ▶ **Smoke:** Tested in accordance with AS1530.7 with medium temperature smoke approvals for use on AS6905 compliant smoke door assemblies. Conforms with BCA Specification C3.4 smoke sealing requirements.
- ▶ **Sound:** Acoustically tested in accordance with ISO10140-2 and AS/NZS717.1 with ratings up to 37Rw on appropriate rated assemblies.
- ▶ **Bushfire:** Approved for use on proprietary fire door assemblies for Bushfire attack levels of Flame Zone (FZ) classification or less.
- ▶ **Durability:** Long term mechanical test, completing 100,000 cycles without failure.

### Fixing method

- ▶ Face-fixed or semi-mortised. Fixing screws are supplied.

### Standard lengths

- ▶ 435mm (may be cut back to 335mm)
- ▶ 535mm (may be cut back to 435mm)
- ▶ 635mm (may be cut back to 535mm)
- ▶ 735mm (may be cut back to 635mm)
- ▶ 820mm (may be cut back to 735mm)
- ▶ 920mm (may be cut back to 820mm)
- ▶ 1070mm (may be cut back to 920mm)
- ▶ 1220mm (may be cut back to 1070mm)
- ▶ 1400mm\* (may be cut back to 1220mm)
- ▶ 1600mm\* (may be cut back to 1400mm)

\*Non-standard sizes do not hold test evidence for the approval for use. Speak to our Technical Team for advice.

### Finishes

- ▶ Silver anodised aluminium with grey push-fit end caps & grey silicone rubber gasket.

**Also available as a hot smoke seal** (LAS8002 si HSS) please refer to

## DROP SEALS

# LAS8002G si

## MEDIUM DUTY

Face-fixed drop seal suitable for glass doors – designed for hinged doors into timber or aluminium frames. It is non-reversible and needs to be ordered left or right handed. LAS8002G features a high efficiency mechanism which lifts the seal clear of the floor as soon as the door is opened by a few millimetres; resulting in lower door operating forces. It requires no power connection. Surface mounted application suitable for upgrading existing doors.



DROP SEALS

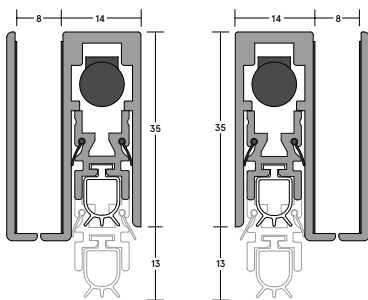

LAS8002G si  
(right handed)

LAS8002G si  
(left handed)

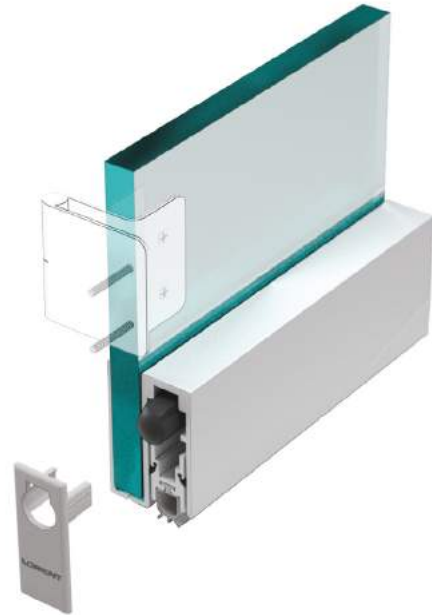

LAS8002G si

## SYSTEM SPECIFICATIONS

### Key benefits

- ▶ Effective acoustic sealing solution that can easily be retrofitted to existing door assemblies.
- ▶ Dual internal sealing fins enhance acoustic and smoke containment performance.
- ▶ Quick and easy installation.
- ▶ Supplied with a silicone rubber gasket and aesthetic push-fit end caps.
- ▶ Fully automatic, no power connection required.
- ▶ Simple adjustment to suit varying door gap requirements.
- ▶ Suitable for various glass thicknesses from 8mm.
- ▶ Proven long term reliability.

### Approvals

- ▶ **Smoke:** Conforms with BCA Specification C3.4 smoke sealing requirements (Applicable to glass door conforms to BCA C3.4 smoke requirement).
- ▶ **Sound:** Acoustically tested in accordance with ISO10140-2 and AS/NZS717.1 with ratings up to 31Rw on appropriate rated assemblies.
- ▶ **Durability:** Tested for reliability, the seal completed 100,000 cycles without failure.

### Gap sizes

- ▶ Accommodates and seals 3mm - 10mm gaps.
- ▶ Greater gaps can be sealed if product is used with a threshold plate, please speak to our technical team for more info.

### Fixing method

- ▶ LAS8002G carrier and back plate is face-fixed with strong adhesive tape.
- ▶ This product is non-reversible and needs to be ordered left or right handed.

### Standard lengths

- ▶ 820mm (may be cut back to 735mm)
- ▶ 920mm (may be cut back to 820mm)
- ▶ 1070mm (may be cut back to 920mm)

### Finishes

- ▶ Silver anodised aluminium with push fit stainless steel end plates and grey silicone rubber gasket.

DROP SEALS

# LAS8003 si

MEDIUM DUTY

A slimline face-fixed or semi-mortised automatic drop seal; used to close the gap under single swing doors to maintain their acoustic, smoke and energy efficiency performance. The seal incorporates a high efficiency spring loaded mechanism that extends the seal as the door swings shut and automatically retracts it as the door is opened by just a few centimetres.

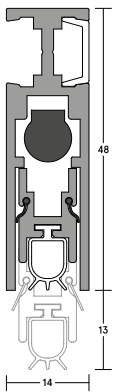

LAS8003 si



LAS8003 si

DROP SEALS

SYSTEM SPECIFICATIONS

**Key benefits**

- ▶ Effective acoustic sealing solution that can easily be retrofitted to existing door assemblies.
- ▶ Dual internal sealing fins enhance acoustic & smoke containment performance.
- ▶ Fixing points are fully concealed behind a click-fit cover strip.
- ▶ Quick and easily installation.
- ▶ May be fitted semi-mortised for a flush finish.
- ▶ Supplied with a fire rated silicone rubber gasket and colour matched push-fit end caps.
- ▶ Fully automatic, no power connection required.
- ▶ Simple adjustment to suit varying door gap requirements.
- ▶ Proven long term reliability.

**Fixing method**

- ▶ Face-fixed or semi-mortised. Fixing screws are supplied.

**Approvals**

- ▶ **Fire:** Tested in accordance with AS1530.4 on proprietary AS1905.1 fire door assemblies for up to 4 hour rating.
- ▶ **Smoke:** Tested in accordance with AS1530.7 with medium temperature smoke approvals for use on AS6905 compliant smoke door assemblies. Conforms with BCA Specification C3.4 smoke sealing requirements.
- ▶ **Sound:** Acoustically tested in accordance with ISO10140-2 and AS/NZS717.1 with ratings up to 37Rw on appropriate rated assemblies.
- ▶ **Bushfire:** Approved for use on proprietary fire door assemblies for Bushfire attack levels of Flame Zone (FZ) classification or less.
- ▶ **Durability:** Long term mechanical test, completing 100,000 cycles without failure.

**Gap sizes**

- ▶ Accommodates & seals 1mm to 13mm gaps.
- ▶ Greater gaps can be sealed if product is used with a threshold plate.

**Standard lengths**

- ▶ 435mm (may be cut back to 335mm)
- ▶ 535mm (may be cut back to 435mm)
- ▶ 635mm (may be cut back to 535mm)
- ▶ 735mm (may be cut back to 635mm)
- ▶ 820mm (may be cut back to 735mm)
- ▶ 920mm (may be cut back to 820mm)
- ▶ 1070mm (may be cut back to 920mm)
- ▶ 1220mm (may be cut back to 1070mm)
- ▶ 1400mm\* (may be cut back to 1220mm)
- ▶ 1600mm\* (may be cut back to 1400mm)

\*Non-standard sizes do not hold test evidence for the approval for use. Speak to our Technical Team for advice.

**Finishes**

- ▶ Silver anodised aluminium with stainless steel end plates & grey silicone rubber gasket.

**Also available as a hot smoke seal** (LAS8003 si HSS) please refer to

## DROP SEALS

# LAS8004 si

## HEAVY DUTY

A heavy duty, mortised, automatic 'flat back' drop seal designed for installation into hollow aluminium door bottom rails. It features a high efficiency mechanism, which lifts the seal clear of the floor as soon as the door is opened by a few millimetres; resulting in lower door operating forces.



DROP SEALS

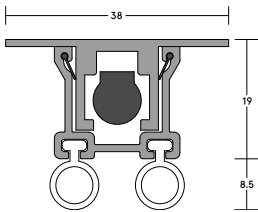

LAS8004 si



LAS8004 si  
shown with LAS4002

## SYSTEM SPECIFICATIONS

### Key benefits

- ▶ Requires no power connection.
- ▶ Self-levelling on uneven floors, seal height can be adjusted independently of fixing screws.

### Gap sizes

- ▶ Accommodates & seals gaps from 1mm to 13mm.
- ▶ Greater gaps can be sealed if product is used with a threshold plate, please speak to our technical team for more info.

### Approvals

- ▶ Durability: Tested for reliability, the seal completed 100,000 cycles without failure.

### Fixing method

- ▶ Fixing screws are supplied, fixing holes are pre-drilled.

### Standard lengths

- ▶ 820mm (may be cut back to 735mm)
- ▶ 920mm (may be cut back to 820mm)
- ▶ 1070mm (may be cut back to 920mm)
- ▶ 1220mm (may be cut back to 1070mm)

### Finishes

- ▶ Silver anodised aluminium.



## DROP SEALS

# LAS8005 si

## HEAVY DUTY

A slimline, fully mortised automatic drop seal. It features a silicone rubber gasket and internal fins. It is used to close the gap under single swing doors to maintain their acoustic, smoke and energy efficiency performance. The seal incorporates a high efficiency spring loaded mechanism that extends the seal as the door swings shut and automatically retracts it as the door is opened by just a few centimetres.

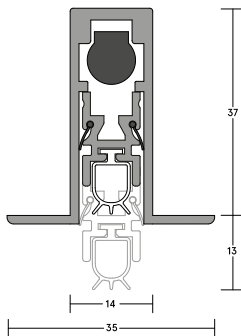

▲ LAS8005 si



▲ LAS8005 si  
shown with LAS4002

DROP SEALS

## SYSTEM SPECIFICATIONS

### Key benefits

- ▶ Fully concealed and mechanically fixed to the bottom of the door through the flanges.
- ▶ Dual internal sealing fins enhance acoustic and smoke containment performance.
- ▶ Supplied with high performance fire rated silicone rubber gasket and aesthetic colour matched end caps.
- ▶ Fully automatic, no power connection required.
- ▶ Simple adjustment to suit varying door gap requirements.
- ▶ Proven long term reliability.

### Gap sizes

- ▶ Accommodates & seals gaps up to 13mm.
- ▶ Greater gaps can be sealed if product is used with a threshold plate, please speak to our technical team for more info.

### Approvals

- ▶ **Fire:** Tested in accordance with AS1530.4 on proprietary AS1905.1 fire door assemblies for up to 4 hour rating.
- ▶ **Smoke:** Tested in accordance with AS1530.7 with medium temperature smoke approvals for use on AS6905 compliant smoke door assemblies. Conforms with BCA Specification C3.4 smoke sealing requirements.
- ▶ **Sound:** Acoustically tested in accordance with ISO10140-2 and AS/NZS717.1 with ratings up to 42Rw on appropriate rated assemblies.
- ▶ **Bushfire:** Approved for use on proprietary fire door assemblies for Bushfire attack levels of Flame Zone (FZ) classification or less.
- ▶ **Durability:** Long term mechanical test, completing 100,000 cycles without failure.

### Fixing method

- ▶ Fits into a 15mm wide x 37mm deep groove and retained in place by screw fixing through the seal flanges.

### Standard lengths

- ▶ 435mm (may be cut back to 335mm)
- ▶ 535mm (may be cut back to 435mm)
- ▶ 635mm (may be cut back to 535mm)
- ▶ 735mm (may be cut back to 635mm)
- ▶ 820mm (may be cut back to 735mm)
- ▶ 920mm (may be cut back to 820mm)
- ▶ 1070mm (may be cut back to 920mm)
- ▶ 1220mm (may be cut back to 1070mm)
- ▶ 1400mm\* (may be cut back to 1220mm)

\*Non-standard sizes do not hold test evidence for the approval for use. Speak to our Technical Team for advice.

### Finishes

- ▶ Silver anodised aluminium, stainless steel end plates & grey silicone rubber gasket.

## DROP SEALS

# LAS8006 si

## HEAVY DUTY

A heavy duty, face-fixed or semi-mortised automatic drop seal. It features a silicone rubber gasket and internal fins. It is used to close the gap under single swing doors to maintain the acoustic, smoke and energy efficiency performance. The seal incorporates a high efficiency spring loaded mechanism that extends the seal as the door swings shut and automatically retracts it as the door is opened by just a few centimetres.



DROP SEALS

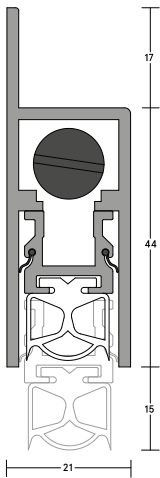

LAS8006 si



LAS8006 si  
shown with LAS4010

### SYSTEM SPECIFICATIONS

#### Key benefits

- ▶ Effective acoustic sealing solution that can easily be retrofitted to existing door assemblies.
- ▶ Dual internal sealing fins enhance acoustic and smoke containment performance.
- ▶ Quickly and easily fitted to the bottom of door.
- ▶ Can be fitted semi-mortised for a flush finish.
- ▶ Supplied with a fire rated silicone rubber gasket and aesthetic push-fit end caps.
- ▶ Fully automatic, no power connection required.
- ▶ Simple adjustment to suit varying door gap requirements.
- ▶ Proven long term reliability.

#### Gap sizes

- ▶ Accommodates & seals gaps up to 15mm.
- ▶ Greater gaps can be sealed if product is used with a threshold plate, please speak to our technical team for more info.

#### Approvals

- ▶ **Fire:** Tested in accordance with AS1530.4 on proprietary AS1905.1 fire door assemblies for up to 4 hour rating.
- ▶ **Smoke:** Tested in accordance with AS1530.7 with medium temperature smoke approvals for use on AS6905 compliant smoke door assemblies. Conforms with BCA Specification C3.4 smoke sealing requirements.
- ▶ **Sound:** Acoustically tested in accordance with ISO10140-2 and AS/NZS717.1 with ratings up to 39Rw on appropriate rated assemblies.
- ▶ **Bushfire:** Approved for use on proprietary fire door assemblies for Bushfire attack levels of Flame Zone (FZ) classification or less.
- ▶ **Durability:** Long term mechanical test, completing 100,000 cycles without failure.

#### Fixing method

- ▶ Face-fixed or semi-mortised to the bottom of the door. Fixing screws are supplied.

#### Standard lengths

- ▶ 435mm (may be cut back to 335mm)
- ▶ 535mm (may be cut back to 435mm)
- ▶ 635mm (may be cut back to 535mm)
- ▶ 735mm (may be cut back to 635mm)
- ▶ 820mm (may be cut back to 735mm)
- ▶ 920mm (may be cut back to 820mm)
- ▶ 1070mm (may be cut back to 920mm)
- ▶ 1220mm (may be cut back to 1070mm)
- ▶ 1400mm\* (may be cut back to 1220mm)
- ▶ 1600mm\* (may be cut back to 1400mm)

\*Non-standard sizes do not hold test evidence for the approval for use. Speak to our Technical Team for advice.

#### Finishes

- ▶ Silver anodised aluminium, grey push-fit end caps & grey silicone rubber gasket.

## DROP SEALS

# LAS8007 si

## HEAVY DUTY

A heavy duty fully mortised automatic drop seal. It features a silicone rubber gasket and internal fins. It is used to close the gap under single swing doors to maintain the acoustic, smoke and energy efficiency performance. The seal incorporates a high efficiency spring loaded mechanism that extends the seal as the door swings shut and automatically retracts it as the door is opened by just a few centimetres.

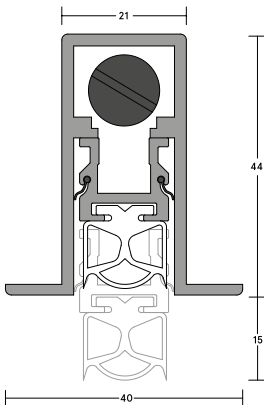

LAS8007 si



LAS8007 si  
shown with LAS4011

DROP SEALS

## SYSTEM SPECIFICATIONS

### Key benefits

- ▶ Dual internal sealing fins enhance acoustic and smoke containment performance.
- ▶ Supplied with high performance fire rated silicone rubber gasket.
- ▶ Fully automatic, no power connection required.
- ▶ Simple adjustment to suit varying door gap requirements.
- ▶ Proven long term reliability.

### Gap sizes

- ▶ Accommodates & seals gaps up to 15mm.
- ▶ Greater gaps can be sealed if product is used with a threshold plate, please speak to our technical team for more info.

### Fixing method

- ▶ Fixing screws are supplied, fixing holes are pre-drilled through the flanges.

### Approvals

- ▶ **Fire:** Tested in accordance with AS1530.4 on proprietary AS1905.1 fire door assemblies for up to 4 hour rating.
- ▶ **Smoke:** Tested in accordance with AS1530.7 with medium temperature smoke approvals for use on AS6905 compliant smoke door assemblies. Conforms with BCA Specification C3.4 smoke sealing requirements.
- ▶ **Sound:** Acoustically tested in accordance with ISO10140-2 and AS/NZS717.1 with ratings up to 39Rw on appropriate rated assemblies.
- ▶ **Bushfire:** Approved for use on proprietary fire door assemblies for Bushfire attack levels of Flame Zone (FZ) classification or less.
- ▶ **Durability:** Long term mechanical test, completing 100,000 cycles without failure.

### Standard lengths

- ▶ 435mm (may be cut back to 335mm)
- ▶ 535mm (may be cut back to 435mm)
- ▶ 635mm (may be cut back to 535mm)
- ▶ 735mm (may be cut back to 635mm)
- ▶ 820mm (may be cut back to 735mm)
- ▶ 920mm (may be cut back to 820mm)
- ▶ 1070mm (may be cut back to 920mm)
- ▶ 1220mm (may be cut back to 1070mm)
- ▶ 1400mm\* (may be cut back to 1220mm)
- ▶ 1600mm\* (may be cut back to 1400mm)

\*Non-standard sizes do not hold test evidence for the approval for use. Speak to our Technical Team for advice.

### Finishes

- ▶ Silver anodised aluminium, grey push-fit end caps & grey silicone rubber gasket.

## DROP SEALS

# LAS8008 si

## MEDIUM DUTY

A slimline face-fixed automatic drop seal with a curved cover plate for enhanced aesthetics. It features a high efficiency mechanism, which lifts the seal clear of the floor as soon as the door is opened by a few millimetres; resulting in lower door operating forces. Self-levelling on uneven floors, seal height can be adjusted independently of fixing screws.



DROP SEALS

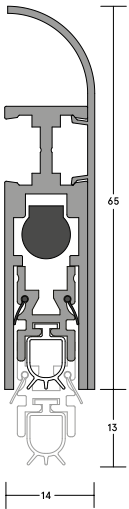

LAS8008 si



LAS8008 si  
shown with LAS4011

## SYSTEM SPECIFICATIONS

### Key benefits

- ▶ Effective acoustic sealing solution that can easily be retrofitted to existing door assemblies.
- ▶ Durable flexible elastomeric fin elements are incorporated with the housing to provide acoustic and smoke properties.
- ▶ It requires no power connection.
- ▶ Curved cover conceals fixing points.
- ▶ Surface mounted application suitable for upgrading existing doors.
- ▶ Proven long term reliability.

### Gap sizes

- ▶ Accommodates & seals gaps up to 13mm.
- ▶ Greater gaps can be sealed if product is used with a threshold plate, please speak to our technical team for more info.

### Fixing method

- ▶ Surface mounted only. Fixing screws are supplied, holes to be drilled at time of fixing.

### Approvals

- ▶ **Fire:** Tested in accordance with AS1530.4 on proprietary AS1905.1 fire door assemblies for up to 4 hour rating.
- ▶ **Smoke:** Tested in accordance with AS1530.7 with medium temperature smoke approvals for use on AS6905 compliant smoke door assemblies. Conforms with BCA Specification C3.4 smoke sealing requirements.
- ▶ **Sound:** Acoustically tested in accordance with ISO10140-2 and AS/NZS717.1 with ratings up to 39Rw on appropriate rated assemblies.
- ▶ **Bushfire:** Approved for use on proprietary fire door assemblies for Bushfire attack levels of Flame Zone (FZ) classification or less.
- ▶ **Durability:** Long term mechanical test, completing 100,000 cycles without failure.

### Standard lengths

- ▶ 435mm (may be cut back to 335mm)
- ▶ 535mm (may be cut back to 435mm)
- ▶ 635mm (may be cut back to 535mm)
- ▶ 735mm (may be cut back to 635mm)
- ▶ 820mm (may be cut back to 735mm)
- ▶ 920mm (may be cut back to 820mm)
- ▶ 1070mm (may be cut back to 920mm)
- ▶ 1220mm (may be cut back to 1070mm)

### Finishes

- ▶ Silver anodised aluminium, grey silicone rubber gasket & grey end caps.
- ▶ Special colours can be supplied using a powder coated finish for additional aesthetics (lead times apply).

## DROP SEALS

# LAS8009 si

## HEAVY DUTY

A heavy duty face-fixed automatic drop seal with a curved cover plate for enhanced aesthetics. It features a spring-loaded mechanism, which lifts the seal clear of the floor as soon as the door is opened by a few millimetres; resulting in lower door operating forces. Self-levelling on uneven floors, seal height can be adjusted independently of fixing screws. Plastic end caps are supplied.

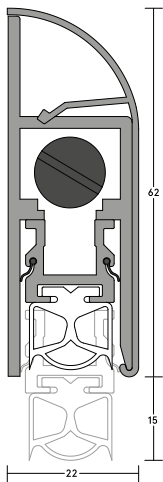

LAS8009 si



LAS8009 si

DROP SEALS

## SYSTEM SPECIFICATIONS

### Key benefits

- ▶ Effective acoustic sealing solution that can easily be retrofitted to existing door assemblies.
- ▶ Dual internal sealing fins enhance acoustic and smoke containment performance.
- ▶ Quickly and easily fitted to the bottom of door.
- ▶ Can be fitted semi-mortised for a flush finish.
- ▶ Supplied with a fire rated silicone rubber gasket and aesthetic push-fit end caps.
- ▶ Fully automatic, no power connection required.
- ▶ Simple adjustment to suit varying door gap requirements.
- ▶ Proven long term reliability.

### Gap sizes

- ▶ Accommodates & seals gaps up to 15mm.

### Approvals

- ▶ **Fire:** Tested in accordance with AS1530.4 on proprietary AS1905.1 fire door assemblies for up to 4 hour rating.
- ▶ **Smoke:** Tested in accordance with AS1530.7 with medium temperature smoke approvals for use on AS6905 compliant smoke door assemblies. Conforms with BCA Specification C3.4 smoke sealing requirements.
- ▶ **Sound:** Acoustically tested in accordance with ISO10140-2 and AS/NZS717.1 with ratings up to 39Rw on appropriate rated assemblies.
- ▶ **Bushfire:** Approved for use on proprietary fire door assemblies for Bushfire attack levels of Flame Zone (FZ) classification or less.
- ▶ **Durability:** Long term mechanical test, completing 100,000 cycles without failure.

### Fixing method

- ▶ Fixing screws are supplied, fixing holes should be drilled at time of fixing.

### Standard lengths

- ▶ 535mm (may be cut back to 435mm)
- ▶ 635mm (may be cut back to 535mm)
- ▶ 735mm (may be cut back to 635mm)
- ▶ 820mm (may be cut back to 735mm)
- ▶ 920mm (may be cut back to 820mm)
- ▶ 1070mm (may be cut back to 920mm)
- ▶ 1220mm (may be cut back to 1070mm)

### Finishes

- ▶ Silver anodised aluminium cover plate, grey silicone rubber gasket, grey & caps.
- ▶ Special colours can be supplied using a powder coated finish for additional aesthetics (lead times apply).



# DOOR BOTTOM SEALS



A range of versatile and hardwearing door bottom seals, that seal the gap between the bottom of the door and the floor.

They can be surface mounted or concealed in a rebated groove at the bottom of the door leaf. Use with a threshold plate for the optimum sealing solution.



## DOOR BOTTOM SEALS

# LAS3001 si & LAS3002 si

## MEDIUM DUTY

Medium duty door bottom and meeting stile seals with slide-in gaskets; ideal for acoustic and smoke containment.

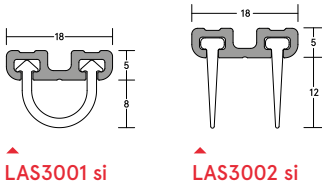

LAS3001 si

LAS3002 si



LAS3001 si

DOOR BOTTOM SEALS

### SYSTEM SPECIFICATIONS

#### Key benefits

- ▶ Simple, effective sealing solution.
- ▶ Easily retrofitted to existing door assemblies.
- ▶ Durable, hard wearing silicone rubber gaskets.
- ▶ Protects against sound, smoke, weather, draught, light and insects.

#### Gap size

- ▶ LAS3001 si – 6mm/13mm.
- ▶ LAS3002 si – 10mm/17mm.

#### Standard lengths

- ▶ 2.1m.
- ▶ Other lengths available to special order.

#### Approvals

- ▶ **Smoke:** Conforms with BCA Specification C3.4 smoke sealing requirements.
- ▶ **Sound:** BS EN ISO 10140-2: 2010. LAS3001 si: Rw 32dB, LAS3002 si: Rw 31dB.
- ▶ **Durability:** Long term mechanical test, completing 100,000 cycles without failure.

#### Fixing method

- ▶ Face-fixed, semi-rebated or fully rebated.
- ▶ Fixing screws are supplied.
- ▶ Fixing holes are pre-drilled.
- ▶ Once the aluminium carrier is fixed, the rubber gasket slides easily into place.
- ▶ Note: these seals cannot be adjusted once fitted.

#### Finishes

- ▶ Silver anodised aluminium with grey silicone rubber insert.

## DOOR BOTTOM SEALS

# LAS3003 si

## MEDIUM DUTY

Medium duty door bottom and meeting stile seals with slide-in gaskets; ideal for acoustic and smoke containment.



DOOR BOTTOM SEALS

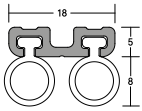

LAS3003 si



LAS3003 si

### SYSTEM SPECIFICATIONS

#### Key benefits

- ▶ Simple, effective sealing solution.
- ▶ Easily retrofitted to existing door assemblies.
- ▶ Durable, hard wearing silicone rubber gaskets.
- ▶ Protects against sound, smoke, weather, draught, light and insects.

#### Gap size

- ▶ 7mm/13mm.

#### Standard lengths

- ▶ 1m and 2.1m.
- ▶ Other lengths to special order.

#### Approvals

- ▶ **Smoke:** Conforms with BCA Specification C3.4 smoke sealing requirements.
- ▶ **Durability:** Long term mechanical test, completing 100,000 cycles without failure.

#### Fixing method

- ▶ Face-fixed, semi-rebated or fully rebated.
- ▶ Fixing screws are supplied.
- ▶ Fixing holes are pre-drilled.
- ▶ Once the aluminium carrier is fixed, the rubber gasket slides easily into place.
- ▶ Note: these seals cannot be adjusted once fitted.

#### Finishes

- ▶ Silver anodised aluminium with grey silicone rubber insert.

## DOOR BOTTOM SEALS

# LAS3004 si

## HEAVY DUTY

A heavy duty, sweep action door bottom seal for easy face-fixed installations. Slimline aesthetic design with flexible cover strip to conceal fixings. It can easily accommodate a range of larger threshold gap sizes.

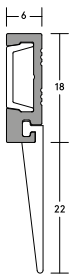

▲ LAS3004 si



▲ LAS3004 si  
shown with LAS4010

DOOR BOTTOM SEALS

### SYSTEM SPECIFICATIONS

#### Key benefits

- ▶ Simple, effective sealing solution.
- ▶ Slim-line, aesthetic design.
- ▶ Easily retrofitted to existing door assemblies.
- ▶ Seal screw-fixed.

#### Gap size

- ▶ 10mm/22mm.

#### Standard lengths

- ▶ 1m, 2.1m, 2.75m and 3m.

#### Approvals

- ▶ **Fire:** Tested in accordance with AS1530.4 on proprietary AS1905.1 fire door assemblies for up to 4 hour rating.
- ▶ **Smoke:** Conforms with BCA Specification C3.4 smoke sealing requirements.
- ▶ **Bushfire:** Approved for use on proprietary fire door assemblies for Bushfire attack levels of Flame Zone (FZ) classification or less.
- ▶ **Durability:** Long term mechanical test, completing 100,000 cycles without failure.

#### Fixing method

- ▶ Fixing screws are supplied.
- ▶ Fixing holes are pre-drilled and slotted to allow the seals to be adjusted and positioned accurately.

#### Finishes

- ▶ Silver anodised aluminium with grey cover strip and grey silicone rubber blade.

## DOOR BOTTOM SEALS

# LAS3007 si

## HEAVY DUTY

A heavy duty weather proof seal, which can be fitted without removing the door, and can be used with a choice of threshold plates. Concealed fixings, pre-drilled and slotted holes on LAS3007 si provide easy adjustment. Durable, anodised aesthetic finish.



DOOR BOTTOM SEALS

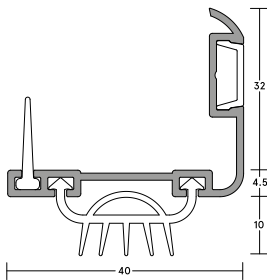

LAS3007 si



LAS3007 si  
shown with LAS4010

### SYSTEM SPECIFICATIONS

#### Key benefits

- ▶ Durable multi-bladed silicone seal.
- ▶ Snap-fit cover strip conceals fixing points.
- ▶ Slotted fixing holes provide simple adjustment.
- ▶ Aesthetic anodised finish.

#### Gap size

- ▶ 16mm/22mm.

#### Standard lengths

- ▶ 1m and 2.1m.
- ▶ Other lengths available to special order.

#### Approvals

- ▶ **Smoke:** Conforms with BCA Specification C3.4 smoke sealing requirements.
- ▶ **Durability:** Long term mechanical test, completing 100,000 cycles without failure.

#### Fixing method

- ▶ Self-tapping screws are supplied.
- ▶ Fixing holes are pre-drilled and slotted to allow the seals to be adjusted and positioned accurately. A snap-fit cover strip to conceal fixings is supplied.

#### Finishes

- ▶ Silver anodised aluminium with grey cover strip and grey silicone rubber blade.

## DOOR BOTTOM SEALS

# LAS3008 si

## MEDIUM DUTY

A multi-blade, storm-proof seal combination consisting of the LAS3007 si door bottom seal and LAS4015 threshold plate. Durable, anodised aesthetic finish. It can be fitted without removing the door. Concealed fixings, pre-drilled and slotted holes on LAS3007 si for easy adjustment.

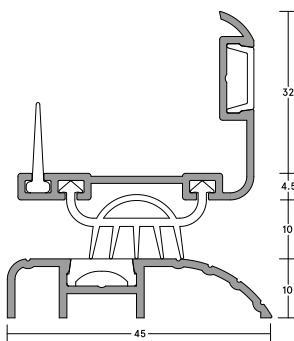

↑  
LAS3008 si



DOOR BOTTOM SEALS

### SYSTEM SPECIFICATIONS

#### Key benefits

- ▶ Durable multi-bladed silicone seal.
- ▶ Snap-fit cover strip conceals fixing points.
- ▶ Slotted fixing holes provide simple adjustment.
- ▶ Aesthetic anodised finish.

#### Gap size

- ▶ 26mm/32mm.

#### Standard lengths

- ▶ 1m and 2.1m. Other lengths to special order.

#### Approvals

- ▶ **Smoke:** Conforms with BCA Specification C3.4 smoke sealing requirements.
- ▶ **Durability:** Long term mechanical test, completing 100,000 cycles without failure.

#### Fixing method

- ▶ LAS3007 si – Self-tapping wood screws are supplied (self-drilling and self-tapping screws for metal construction available on request). Fixing holes are predrilled and slotted to allow the seals to be adjusted and positioned accurately.
- ▶ A PVC cover strip to conceal fixings is supplied.
- ▶ LAS4015 – Fixing screws are supplied. PVC cover strip to conceal fixings is supplied.

#### Finishes

- ▶ LAS3007 si – Silver anodised aluminium with grey cover strip and grey silicone rubber gasket.
- ▶ LAS4015 – Silver anodised aluminium with grey cover strip.

## DOOR BOTTOM SEALS

# LAS3009 si

## MEDIUM DUTY

Medium duty door bottom seal with slide-in gaskets. Suitable for single and double swing doors, or to use as meeting stiles (one leaf only).



DOOR BOTTOM SEALS

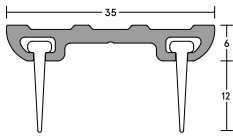

↑ LAS3009 si



↑ LAS3009 si  
shown with LAS4002

### SYSTEM SPECIFICATIONS

#### Key benefits

- ▶ Simple, effective sealing solution.
- ▶ Easily retrofitted to existing door assemblies.
- ▶ Durable, hard wearing silicone rubber gaskets.
- ▶ Protects against sound, smoke, weather, draught, light and insects.

#### Gap size

- ▶ 12mm/18mm.

#### Standard lengths

- ▶ 1m and 2.1m.
- ▶ Other lengths available to special order.

#### Approvals

- ▶ **Smoke:** Conforms with BCA Specification C3.4 smoke sealing requirements.
- ▶ **Durability:** Long term mechanical test, completing 100,000 cycles without failure.

#### Fixing method

- ▶ Face-fixed, semi-rebated or fully rebated.
- ▶ Fixing screws are supplied.
- ▶ Fixing holes are pre-drilled.
- ▶ Once the aluminium carrier is fixed, the rubber gasket slides easily into place.
- ▶ Note: these seals cannot be adjusted once fitted.

#### Finishes

- ▶ Silver anodised aluminium with grey silicone rubber insert.



# THRESHOLD PLATES + RAMPS

Hardwearing aluminium and stainless steel threshold plates and ramps that are affixed to the sill beneath the door. Threshold plates provide a firm and effective sealing surface for threshold seals to rest against, while also covering the join between different flooring materials.

Threshold ramps feature a gentle sloping gradient to accommodate differences in floor heights.

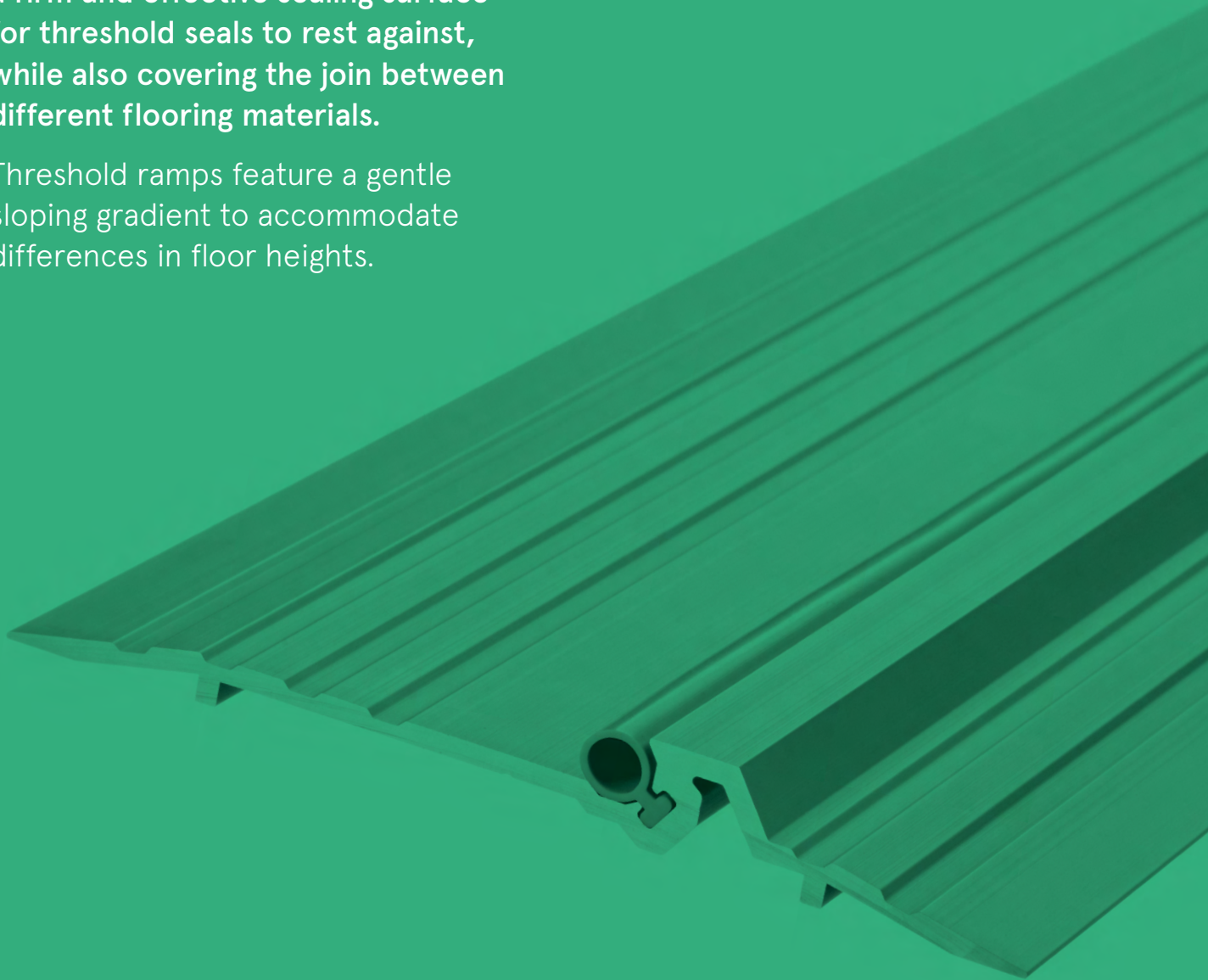

# LAS4002

## MEDIUM DUTY

Medium duty, gently curved low-profile aluminium threshold plate. Used where the door sill is uneven, this threshold plate creates a level sealing surface that greatly enhances the ability of door bottom seals to restrict the passage sound, smoke, energy or weather.

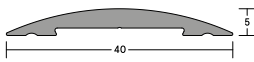

LAS4002

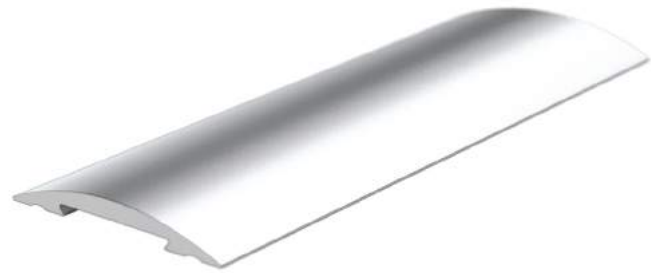

LAS4002

### SYSTEM SPECIFICATIONS

#### Key benefits

- ▶ Creates a flat sealing surface.
- ▶ Enhances the performance of other sealing systems.
- ▶ Slim-line geometry satisfies AS1428.1 access for people with disability requirements.
- ▶ Durable hard wearing anodised finish.

#### Gap sizes

- ▶ Minimum 6mm door undercut.

#### Fixing method

- ▶ Mechanically fixed to threshold with supplied screw pack or adhered with construction adhesive.

#### Approvals

- ▶ **Fire:** Tested in accordance with AS1530.4 on proprietary AS1905.1 fire door assemblies up to 4 hour rating.
- ▶ **Sound:** Acoustically tested as part of a system in accordance with ISO10140-2 and AS/NZS717.1.
- ▶ **Bushfire:** Approved for use on proprietary fire door assemblies for Bushfire attack levels of Flame Zone (FZ) classification or less.

#### Standard lengths

- ▶ 1m and 2.1m.
- ▶ Other lengths available to special order.

#### Finishes

- ▶ Silver anodised aluminium.

# LAS4010, LAS4011, LAS4012 & LAS4013

## MEDIUM DUTY

Medium duty, low profile aluminium threshold plates, only 6mm high. Ideal for wheeled traffic. These plates can increase the effectiveness of threshold (door bottom) seals by creating a firmer gasket contact; preventing rain, draught and smoke penetration.

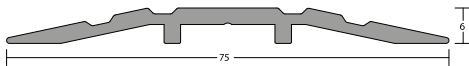
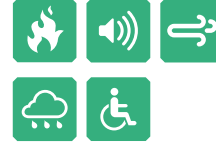

LAS4010

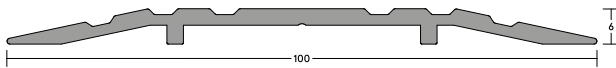

LAS4011

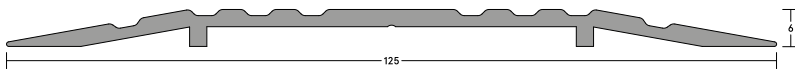

LAS4012

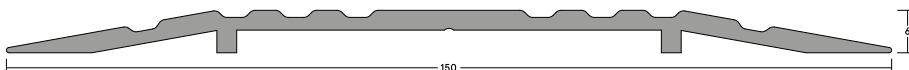

LAS4013



LAS4010

### SYSTEM SPECIFICATIONS

#### Key benefits

- ▶ When used in conjunction with threshold (door bottom) seals, these plates prevent rain, draught & smoke penetration.
- ▶ Quick and easy installation
- ▶ Durable anodised aesthetic finish.

#### Gap sizes

- ▶ Minimum 6mm door undercut.

#### Fixing method

- ▶ Fixing screws are supplied.

#### Approvals

- ▶ **Fire:** Tested in accordance with AS1530.4 on proprietary AS1905.1 fire door assemblies up to 4 hour rating.
- ▶ **Sound:** Acoustically tested as part of a system in accordance with ISO10140-2 and AS/NZS717.1.
- ▶ **Bushfire:** Approved for use on proprietary fire door assemblies for Bushfire attack levels of Flame Zone (FZ) classification or less.

#### Standard lengths

- ▶ 1m, 2.1m and 3m.
- ▶ Other lengths available to special order.

#### Finishes

- ▶ Silver anodised aluminium.

# LAS4014 si

## HEAVY DUTY

Heavy duty, aluminium, stepped threshold plate suitable for outward opening doors to prevent rain, draught, light and noise penetration. Can increase the effectiveness of threshold (door bottom) seals by creating a firmer gasket contact. Durable anodised aesthetic finish.

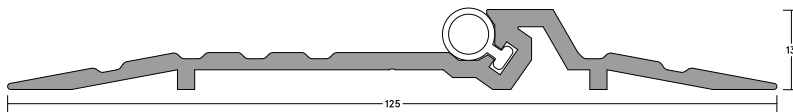

LAS4014 si



### SYSTEM SPECIFICATIONS

#### Key benefits

- ▶ Features a high performance silicone compression seal which helps resist rain, light, dust and noise penetration.
- ▶ Durable anodised aesthetic finish.

#### Approvals

- ▶ **Fire:** Tested in accordance with AS1530.4 on proprietary AS1905.1 fire door assemblies up to 4 hour rating.
- ▶ **Sound:** Acoustically tested as part of a system in accordance with ISO10140-2 and AS/NZS717.1.
- ▶ **Bushfire:** Approved for use on proprietary fire door assemblies for Bushfire attack levels of Flame Zone (FZ) classification or less.

#### Gap sizes

- ▶ Minimum 6mm door undercut.

#### Standard lengths

- ▶ 1m and 2.1m.
- ▶ Other lengths available to special order.

#### Fixing method

- ▶ Fixing screws are supplied.

#### Finishes

- ▶ Silver anodised aluminium with grey silicone rubber gasket.

# LAS4015

## HEAVY DUTY

Heavy duty, aluminium threshold plate suitable for outward opening doors to prevent rain, draught and light. Can increase the effectiveness of threshold seals by creating a firmer gasket contact. Durable anodised aesthetic finish.

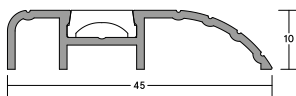

▲ LAS4015



### SYSTEM SPECIFICATIONS

#### Key benefits

- ▶ Durable anodised aesthetic finish.

#### Approvals

- ▶ **Fire:** Tested in accordance with AS1530.4 on proprietary AS1905.1 fire door assemblies for up to 4 hour rating.
- ▶ **Bushfire:** Approved for use on proprietary fire door assemblies for Bushfire attack levels of Flame Zone (FZ) classification or less.

#### Standard lengths

- ▶ 1m and 2.1m.
- ▶ Other lengths available to special order.

#### Fixing method

- ▶ Fixing screws are supplied.

#### Finishes

- ▶ Silver anodised aluminium with grey cover strip.

# BRUSH SEALS



A series of hard-wearing sweep action brush seals suitable for numerous installations and door types; including single and double swing, revolving, sliding, up and over and roller shutter doors.

The independent filaments of the brush conform to irregular surfaces for a more complete seal.



## BRUSH SEALS

# LAS5010, LAS5020, LAS5025 & LAS5030

## MEDIUM DUTY

Hard wearing, medium duty brush seals, suitable for various installations and door types. Suitable for sealing garage doors.

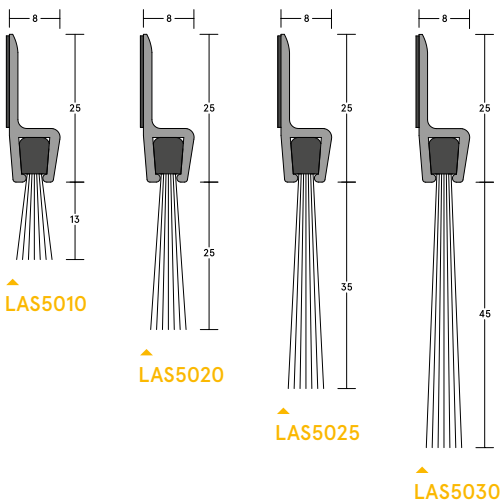

BRUSH SEALS

## SYSTEM SPECIFICATIONS

### Key benefits

- ▶ Flexible and durable.
- ▶ Quick and easy installation.
- ▶ Can be used with any threshold plate.

### Approvals

- ▶ Durability: Long term mechanical test, completing 100,000 cycles without failure.

### Fixing method

- ▶ Heavy duty self-adhesive tape and supplied screw pack.

### Standard lengths

- ▶ 1m, 2.1m and 3m.
- ▶ Seals may be butt jointed together for extended runs.

### Finishes

- ▶ Silver anodised aluminium with black brush filaments.

## BRUSH SEALS

# LAS5035, LAS5040, LAS5045, LAS5050 & LAS5055

## HEAVY DUTY

Hard-wearing, heavy duty brush seals for use with larger gap sizes and more challenging applications. Suitable for sealing garage doors. Nylon brush seals with aluminium carriers.



BRUSH SEALS

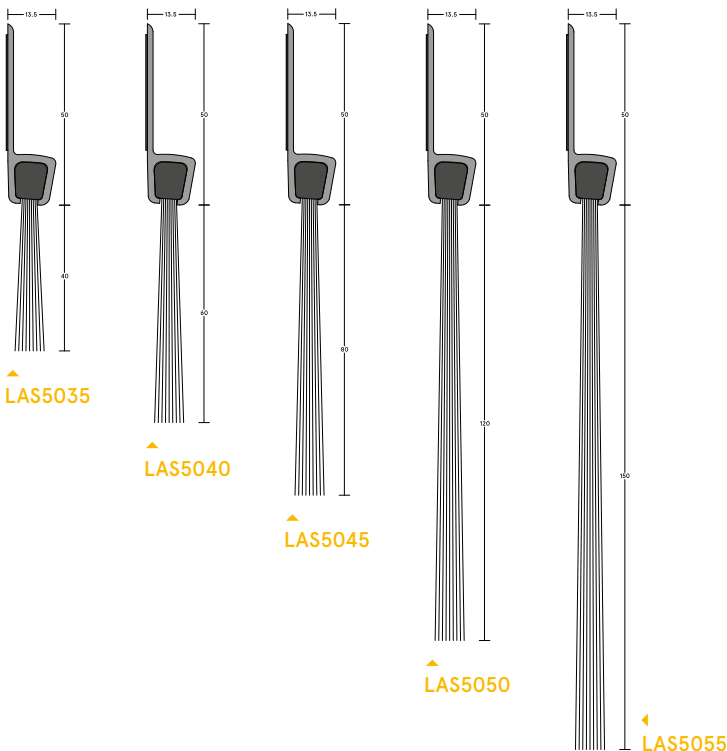

## SYSTEM SPECIFICATIONS

### Key benefits

- ▶ Flexible and durable.
- ▶ Quick and easy installation.
- ▶ Can be used with any threshold plate.
- ▶ Filaments retained in anodised aluminium carrier.

### Approvals

- ▶ Durability: Long term mechanical test, completing 100,000 cycles without failure.

### Gap sizes

- ▶ LAS5035: 20mm/40mm.
- ▶ LAS5040: 40mm/60mm.
- ▶ LAS5045: 60mm/80mm.
- ▶ LAS5050: 80mm/120mm.
- ▶ LAS5055: 120mm/150mm.

### Fixing method

- ▶ Heavy duty self-adhesive tape and supplied screw pack.

### Standard lengths

- ▶ 1m and 2.1m.
- ▶ Seals may be butt jointed together for extended runs.

### Finishes

- ▶ Silver anodised aluminium with black brush filaments.

## BRUSH SEALS

# LAS5060, LAS5065 & LAS5070

## MEDIUM DUTY

Medium duty brushes with right angled carriers, offered with a choice of three brush lengths. Suitable for sealing garage doors.

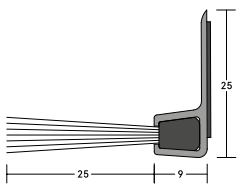

LAS5060

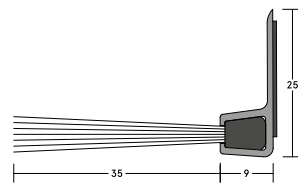

LAS5065

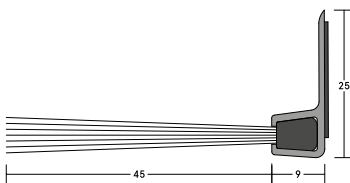

LAS5070



LAS5060

BRUSH SEALS

## SYSTEM SPECIFICATIONS

### Key benefits

- ▶ Flexible and durable.
- ▶ Quick and easy installation.
- ▶ Low friction filaments flex and conform to uneven surfaces.
- ▶ Filaments retained in anodised aluminium carrier.

### Approvals

- ▶ Durability: Long term mechanical test, completing 100,000 cycles without failure.

### Gap sizes

- ▶ LAS5060: 24mm/30mm.
- ▶ LAS5065: 32mm/40mm.
- ▶ LAS5070: 39mm/50mm.

### Fixing method

- ▶ Heavy duty self-adhesive tape and supplied screw pack.

### Standard lengths

- ▶ 1m and 2.1m.
- ▶ Seals may be butt jointed together for extended runs.

### Finishes

- ▶ Silver anodised aluminium with black brush filaments.

## BRUSH SEALS

# LAS5075, LAS5080 & LAS5085

## MEDIUM DUTY

Medium duty brush seals with 45° angled carriers, offered with a choice of three brush lengths. Suitable for sealing garage doors.



BRUSH SEALS

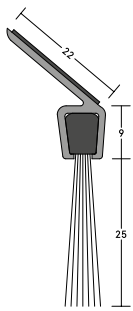

LAS5075

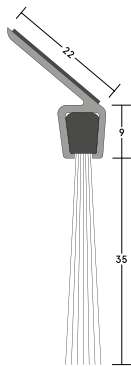

LAS5080

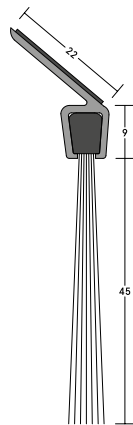

LAS5085



LAS5075

### SYSTEM SPECIFICATIONS

#### Key benefits

- ▶ Flexible and durable.
- ▶ Quick and easy installation.
- ▶ Can be used with any threshold plate.
- ▶ Filaments retained in anodised aluminium carrier.

#### Approvals

- ▶ Durability: Long term mechanical test, completing 100,000 cycles without failure.

#### Gap sizes

- ▶ LAS5075: 19mm/25mm.
- ▶ LAS5080: 25mm/35mm.
- ▶ LAS5085: 35mm/45mm.

#### Fixing method

- ▶ Heavy duty self-adhesive tape and supplied screw pack.

#### Standard lengths

- ▶ 1m and 2.1m.
- ▶ Seals may be butt jointed together for extended runs.

#### Finishes

- ▶ Silver anodised aluminium with black brush filaments.

# FINGER PROTECTION / SPECIALITY SEALS

A range of speciality seals that features finger guards and a flush bolt + drop seal.

Trapping fingers in hinged doors can cause horrendous injuries.

The risk is especially high where young children are present. Our finger guard seals provide a shield, helping prevent thousands of accidents.

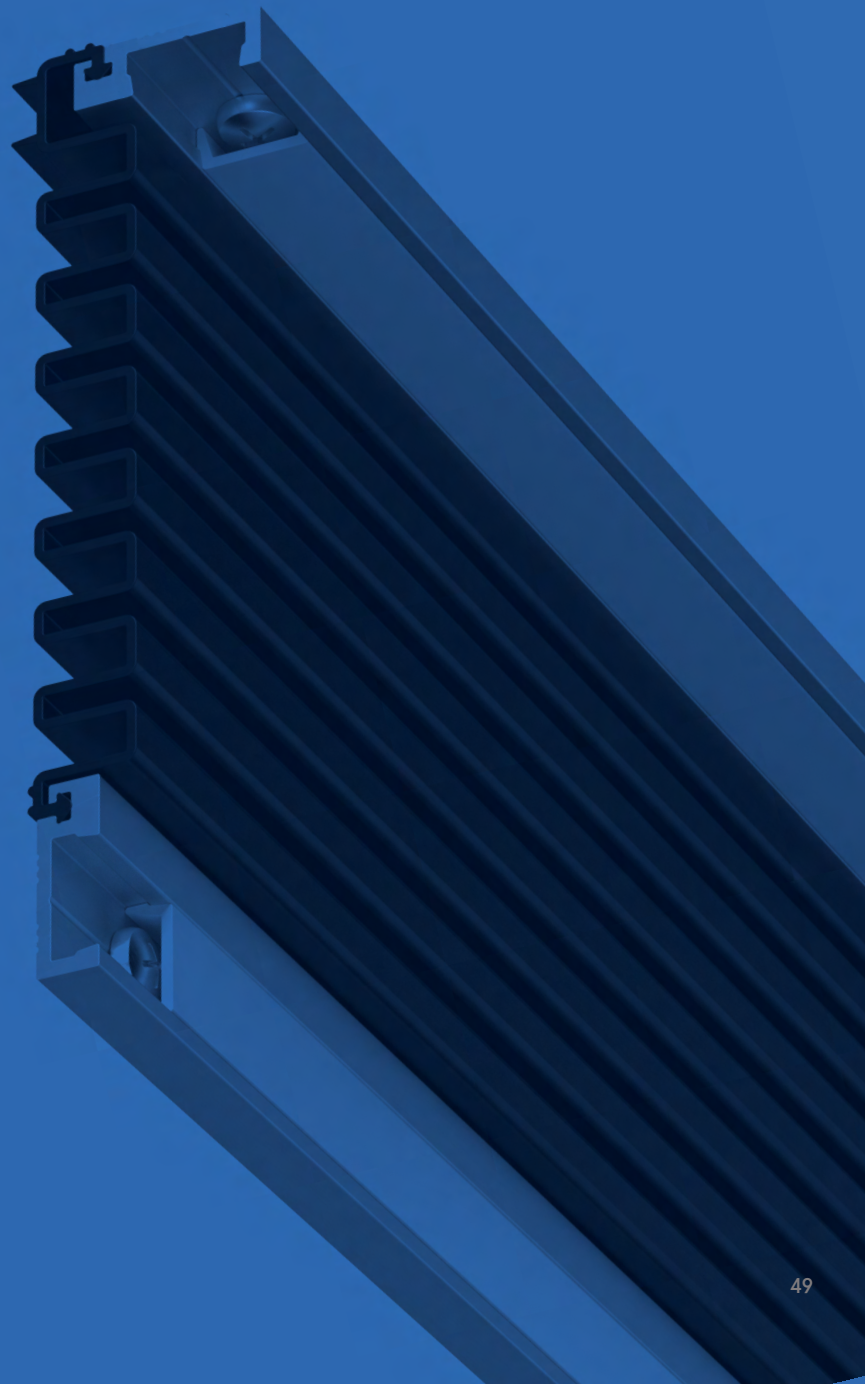

# LAS9010 / LAS8001 si

## MEDIUM DUTY

An innovative, slimline flush bolt that seamlessly integrates with our most popular drop seal – LAS8001 si. The flush bolt is a security device to be used on pairs of doors to secure the inactive leaf. It is activated by a discreet Lorient branded lever, that drops the bolt into a sleek keep in the floor. Specifically designed for use with our rebated high performance drop seal; together they provide the ultimate system combining security, with acoustic, smoke and energy containment at the bottom of the door. The drop seal end plate is not required and no extra adapter kits are needed.

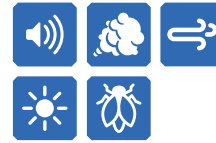

FINGER GUARDS / SPECIALITY SEALS

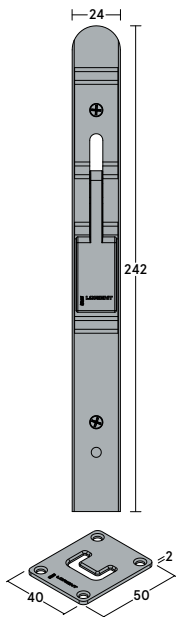

LAS9010



Unlocked



Locked

Patent applied for No. 1718821

### SYSTEM SPECIFICATIONS

#### Key Benefits

- ▶ Protects against sound, smoke, draught, light + insects (LAS8001 si).
- ▶ LAS9010 is a security device. Its unique wrap-around shape of bolt enhances security.
- ▶ Flush bolt integrates seamlessly with the drop seal; no extra kits required.
- ▶ Smooth locking action with branded levers.
- ▶ Does not penetrate the drop seal gasket.

#### Approvals

- ▶ Maintains acoustic performance of drop seal 35dB (BS EN ISO 10140-1: 2010+A2: 2014, Annex J).
- ▶ Durability: 50,000 cycles.

#### Material

- ▶ Flush bolt – brushed stainless steel.
- ▶ Seal material – grey silicone rubber.

#### Location

- ▶ Single action double leaf doors.
- ▶ For use on both right + left handed doors.
- ▶ Suitable for bottom + top of the door.

#### Fixing method

- ▶ LAS9010 is semi-mortised onto the top + bottom of the door. Positioned into the keep. Fixing screws supplied.

#### Use with

- ▶ All standard lengths of LAS8001 si, with the ability to cut to size.
- ▶ Subject to door leaf construction/ specifications.
- ▶ **Note:** Doors must have a sufficient size rebate to accommodate the 24mm wide flush bolt.

#### Gap sizes

- ▶ 1mm/13mm.

#### Drop seal standard lengths

- ▶ 435mm (may be cut back to 335mm)
- ▶ 535mm (may be cut back to 435mm)
- ▶ 635mm (may be cut back to 535mm)
- ▶ 735mm (may be cut back to 635mm)
- ▶ 820mm (may be cut back to 735mm)
- ▶ 920mm (may be cut back to 820mm)
- ▶ 1070mm (may be cut back to 920mm)
- ▶ 1220mm (may be cut back to 1070mm)
- ▶ 1400mm\* (may be cut back to 1220mm)
- ▶ 1600mm\* (may be cut back to 1400mm)

\*Non-standard sizes do not hold test evidence for the approval for use. Speak to our Technical Team for advice.

**Note:** Not approved for use on fire doors.



# LAS9050 si & LAS9070 si

## MEDIUM DUTY

Trapping fingers in hinged doors can cause horrendous injuries. The risk is especially high in locations where young children are present. The finger guard seals provide a deterrent barrier that shields both sides of the hinged door jamb.

FINGER GUARD SEALS

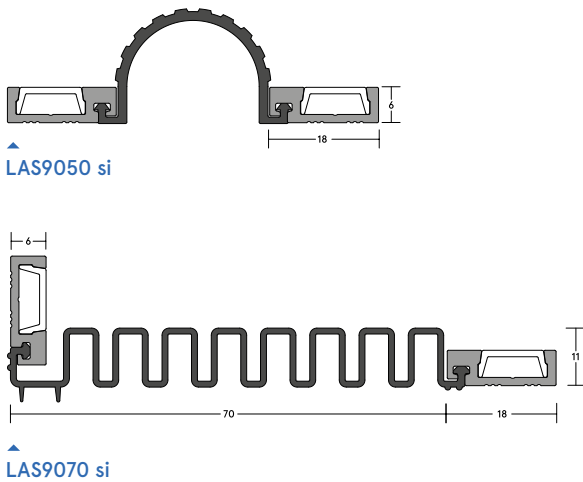

LAS9050 si



LAS9070 si

FINGER GUARDS / SPECIALITY SEALS

### SYSTEM SPECIFICATIONS

#### Key benefits

- ▶ Protection may be provided by using the LAS9050 on the hinge knuckle side and the LAS9070 to the reveal side.
- ▶ LAS9070 includes unique, integral acoustic sealing fins and may be used in conjunction with the LAS7001 si and LAS8001 si to create a comprehensive acoustic sealing and finger protection system.

#### Approvals

- ▶ Durability: Tested over 200,000 full opening and closing cycles without any sign of degradation.

#### Standard lengths

- ▶ 2.1m and 2.75m.
- ▶ Other lengths to special order.

#### Fixing method

- ▶ Fixing screws are supplied. Fixing holes are pre-drilled and slotted to allow the seals to be adjusted and positioned accurately. A PVC cover strip to conceal fixings is supplied.

#### Please note

- ▶ We do not recommend using the LAS9070 si on an aluminium frame.
- ▶ Please note: when LAS9050 si and LAS9070 si are used together, the door can only open up to 170 degrees.

#### Finishes

- ▶ Silver anodised aluminium with grey cover strip and black gasket.



## SPECIALITY SEALS

# LAS9001

## MEDIUM DUTY

An overhead drip guard designed to channel rain water away from exposed doors, particularly those which open outward. Can also be used to deflect rainwater from the bottom of the door.



FINGER GUARDS / SPECIALITY SEALS

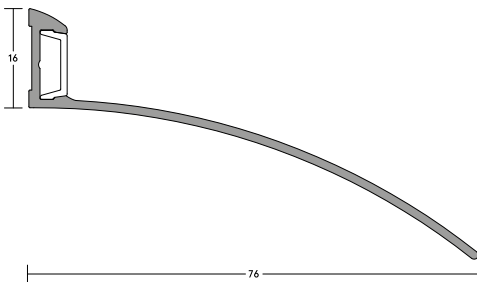

LAS9001



SPECIALITY SEALS

## SYSTEM SPECIFICATIONS

### Key benefits

- ▶ Protects against weather/rain.

### Standard lengths

- ▶ 1m and 2.1m.

### Fixing method

- ▶ Steel screws are supplied (self-drilling and self-tapping screws for metal construction available on request).
- ▶ A PVC cover strip conceals the fixings.
- ▶ Allow an overlap of 50mm on each side of door opening.

### Finish

- ▶ Silver anodised aluminium.

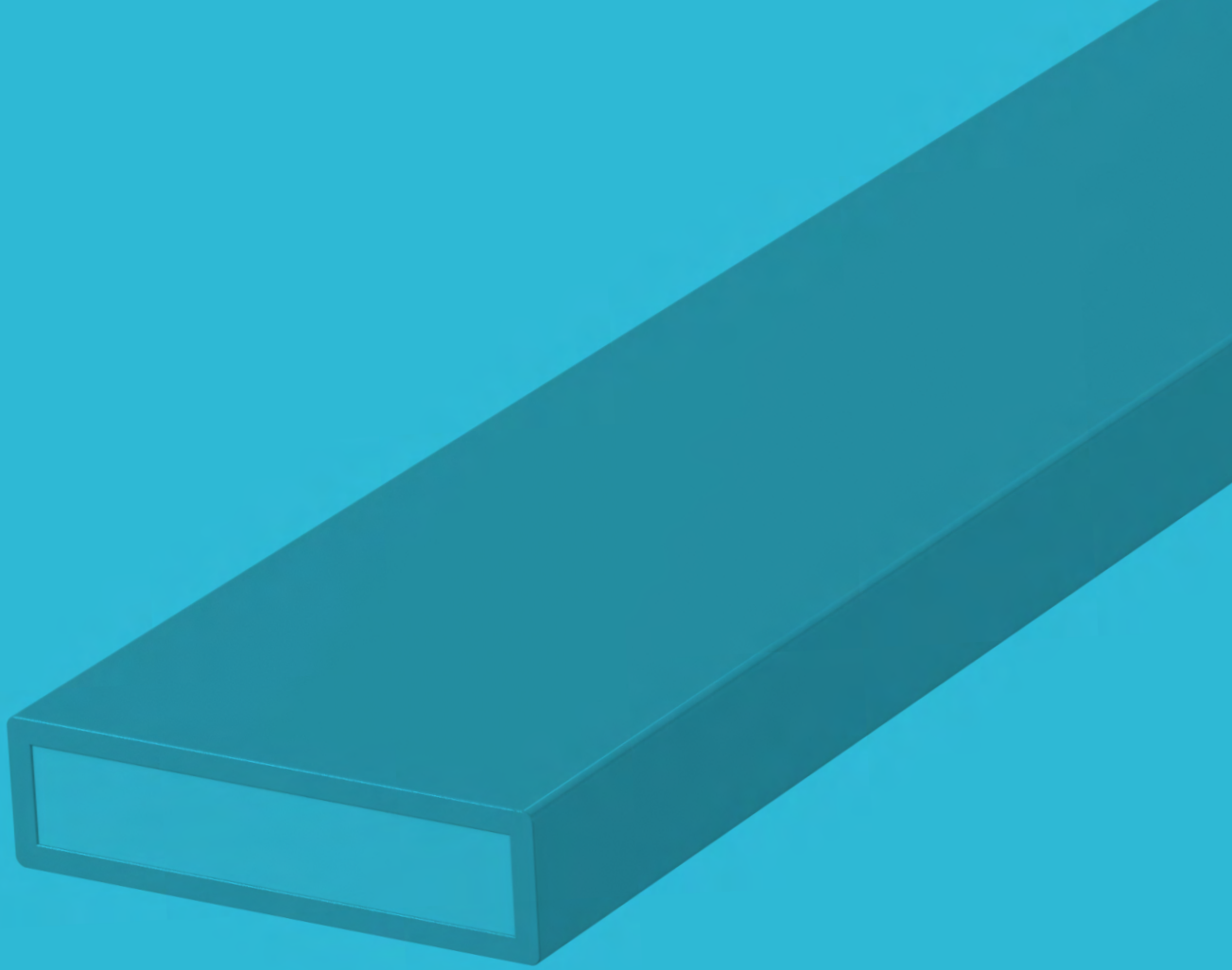

# FIRE + SMOKE SEALS

Clearances around the four sides of a fire door leaf are essential – it's the only way the door can operate effectively. But these clearances create a point of weakness, which fire will readily exploit. This range of intumescent seals protect these clearances.

Most of the seals shown in this section are multi-functional – offering comprehensive protection against fire, ambient & elevated temperature smoke.

# LAS1812 LSS

## MEDIUM DUTY

This slim-line, dual function life safety seal is fitted to door frames to restrict the spread of ambient and elevated temperature smoke. When exposed to fire conditions, the intumescent core rapidly expands in volume to restrict the passage of hot smoke and toxic gases.

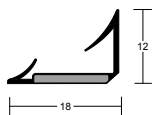

LAS1812 LSS



LAS1812 LSS

FIRE + SMOKE SEALS

### SYSTEM SPECIFICATIONS

#### Key benefits

- ▶ All-in-one **"life safety"** seal. Ideal for use in fire engineering solutions to limit the spread of fire, ambient, medium and hot temperature smoke around the edges of doors.
- ▶ Easily retrofitted to existing door assemblies.
- ▶ Dual sealing fins accommodate significant door deflection to maintain effective sealing performance.
- ▶ Dual low friction curved elastomeric fins provide outstanding acoustic performance.
- ▶ Discreetly positioned in frame rebate to provide a fully concealed sealing solution.
- ▶ Simple peel-and-stick installation, our aggressive self-adhesive backing is tested on many surfaces to ensure seal longevity.

- ▶ Seal surface and fins contain anti-microbial additives to restrict bacterial growth.
- ▶ Combine with LAS8001 si for complete **"life safety door"** sealing solution.

#### Approvals

- ▶ **Fire:** Tested in accordance with AS1530.4 on proprietary AS1905.1 fire door assemblies for up to 4 hour rating..
- ▶ **Smoke:** AS1530.7 smoke test data on AS6905 compliant smoke door assemblies.
- ▶ **Sound:** Acoustically tested in accordance with ISO10140-2 and AS/NZS717.1 with ratings up to Rw39 on appropriate rated assemblies.
- ▶ **Bushfire:** Approved for use on proprietary fire door assemblies for Bushfire attack levels of Flame Zone (FZ) classification or less.

#### Gap sizes

- ▶ 3mm.

#### Fixing method

- ▶ Aggressive film backed self-adhesive.

#### Standard lengths

- ▶ 1m, 2.1m and 2.75m.
- ▶ Single doorset (SDS): (1 x 1m, 2 x 2.1m).
- ▶ Long Single doorset (LSDS): (1 x 1m, 2 x 2.75m).
- ▶ Double doorset (DDS): (3 x 2.1m).
- ▶ Long double doorset (LDDS): (1 x 2.1m, 2 x 2.75m).

#### Finishes

- ▶ Standard colour: Black with black fins.
- ▶ White & brown available to special order.

# LAS400TF

## MEDIUM DUTY FOR STEEL DOOR FRAMES

This slim high performance intumescent fire and smoke seal is designed to upgrade existing door assemblies that are required to restrict the passage of hot temperature smoke. The dual flexible fins retard the spread of smoke and when exposed to elevated temperatures, the intumescent core rapidly expands in volume to restrict the passage of fire, hot smoke and toxic gases.

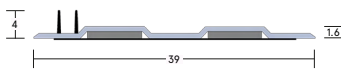

▲ LAS400TF



▲ LAS400TF

FIRE + SMOKE SEALS

### SYSTEM SPECIFICATIONS

#### Key benefits

- ▶ Slim-line retrofit fire and smoke upgrade solution.
- ▶ Simple peel-and-stick installation, our aggressive self-adhesive backing is tested on many surfaces to ensure seal longevity.
- ▶ Ideal for use in fire engineering solutions to limit the spread of smoke and hot gasses around the edges of doors.
- ▶ Seal surface and fins contain anti-microbial additives to restrict bacterial growth.
- ▶ Combine with LAS8001 si for complete "life safety door" sealing solution.

#### Approvals

- ▶ **Fire:** Tested in accordance with AS1530.4 on proprietary AS1905.1 fire door assemblies for up to 4 hour rating.
- ▶ **Bushfire:** Approved for use on proprietary fire door assemblies for Bushfire attack levels of Flame Zone (FZ) classification or less.

#### Gap sizes

- ▶ 3mm.

#### Fixing method

- ▶ Aggressive film backed self-adhesive.

#### Standard lengths

- ▶ 1m, 2.1m and 2.75m.

#### Finishes

- ▶ White.

## FIRE + SMOKE SEALS

# LAS1602BB

## MEDIUM DUTY

This slim-line, dual function seal is fitted to door frames to restrict the spread of ambient and elevated temperature smoke. When exposed to fire conditions, the intumescent core rapidly expands in volume to restrict the passage of hot smoke and toxic gases.

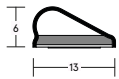

LAS1602BB

FIRE + SMOKE SEALS



LAS1602BB  
Shown with LAS8001 si

## SYSTEM SPECIFICATIONS

### Key benefits

- ▶ All-in-one **"life safety"** seal. Ideal for use in fire engineering solutions to limit the spread of fire and smoke around the edges of doors.
- ▶ Easily retrofitted to existing door assemblies, electrical cupboards, or access panels.
- ▶ Low profile elastomeric bubble provides additional acoustic performance.
- ▶ Discretely positioned in frame rebate to provide a fully concealed sealing solution.
- ▶ Simple peel-and-stick installation, our aggressive self-adhesive backing is tested on many surfaced to ensure seal longevity.
- ▶ Seal surface contains anti-microbial additives to restrict bacterial growth.
- ▶ Combine with LAS8001 si for complete **"life safety door"** sealing solution.

### Approvals

- ▶ **Fire:** Tested in accordance with AS1530.4 on proprietary AS1905.1 fire door assemblies for up to 4 hour rating.
- ▶ **Bushfire:** Approved for use on proprietary fire door assemblies for Bushfire attack levels of Flame Zone (FZ) classification or less.

### Gap sizes

- ▶ 3mm.

### Fixing method

- ▶ Aggressive film backed self-adhesive.

### Standard lengths

- ▶ 2.1m and 2.75m lengths available.

### Finishes

- ▶ Standard colour: Black.

# LAS1602

## MEDIUM DUTY

This slim flexible intumescent fire seal is fitted to door frames to enhance their fire resistance characteristics. When exposed to elevated temperatures, the intumescent core rapidly expands in volume to restrict the passage of fire, hot smoke and toxic gases.



LAS1602



LAS1602

FIRE + SMOKE SEALS

### SYSTEM SPECIFICATIONS

#### Key benefits

- ▶ Ideal for use in fire engineering solutions to enhance fire performance and limit the spread of hot gases around the edges of doors.
- ▶ Easily retrofitted to existing door assemblies.
- ▶ Simple peel-and-stick installation, our aggressive self-adhesive backing is tested on many surfaces to ensure seal longevity.
- ▶ Supplied in standard length coils to minimise on-site wastage.
- ▶ Seal surface contains anti-microbial additives to restrict bacterial growth.
- ▶ Use in conjunction with a LAS1212 Batwing® seal and LAS8001 si drop seal for a complete "life safety door" sealing solution.

#### Approvals

- ▶ **Fire:** Tested in accordance with AS1530.4 on proprietary AS1905.1 fire door assemblies for up to 4 hour rating.
- ▶ **Bushfire:** Approved for use on proprietary fire door assemblies for Bushfire attack levels of Flame Zone (FZ) classification or less.

#### Gap sizes

- ▶ 2.5mm - 3mm.

#### Fixing method

- ▶ Aggressive film backed self-adhesive.

#### Standard lengths

- ▶ 75m coils.

#### Finishes

- ▶ Standard colour: Black.

## FIRE + HOT SMOKE SEALS

# LAS1202

## MEDIUM DUTY

This slim flexible intumescent fire seal is fitted to door frames to enhance their fire resistance characteristics. When exposed to elevated temperatures, the intumescent core rapidly expands in volume to restrict the passage of fire, hot smoke and toxic gases.

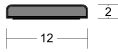

LAS1202



LAS1202

### SYSTEM SPECIFICATIONS

#### Key benefits

- ▶ Ideal for use in fire engineering solutions to enhance fire performance and limit the spread of hot gases around the edges of doors.
- ▶ Easily retrofitted to existing door assemblies.
- ▶ Simple peel-and-stick installation, our aggressive self-adhesive backing is tested on many surfaces to ensure seal longevity.
- ▶ Supplied in standard length coils to minimise on-site wastage.
- ▶ Seal surface contains anti-microbial additives to restrict bacterial growth.

#### Gap sizes

- ▶ 2.5mm - 3mm.

#### Approvals

- ▶ **Fire:** Tested in accordance with AS1530.4 on proprietary AS1905.1 fire door assemblies for up to 4 hour rating.
- ▶ **Bushfire:** Approved for use on proprietary fire door assemblies for Bushfire attack levels of Flame Zone (FZ) classification or less.

#### Fixing method

- ▶ Aggressive film backed self-adhesive.

#### Standard lengths

- ▶ 75m coils.

#### Finishes

- ▶ Standard colour: Black.



## FIRE SEALS

# LP1004, LP1504 & LP2004

## MEDIUM DUTY

These cased intumescent strips are fitted into the door edge or timber frame to restrict the spread of fire and hot smoke. When exposed to fire conditions, the intumescent core rapidly expands in volume to restrict the passage of hot smoke and toxic gases.

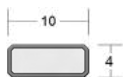

LP1004



LP1504



LP2004



LP1504

FIRE + SMOKE SEALS

## SYSTEM SPECIFICATIONS

### Key benefits

- ▶ Ideal for use in fire engineering solutions to limit the spread of fire and hot smoke around the edges of doors.
- ▶ May be used to improve fire performance of existing door assemblies.
- ▶ Seal casing contains anti-microbial additives to restrict bacterial growth.
- ▶ Use in conjunction with a LAS1212 Batwing® seal and LAS8001 si drop seal for a complete "life safety door" sealing solution.

### Gap sizes

- ▶ 3mm - 4mm.

### Approvals

- ▶ **Fire:** Tested in accordance with AS1530.4 on proprietary AS1905.1 fire door assemblies for up to 4 hour rating.
- ▶ **Bushfire:** Approved for use on proprietary fire door assemblies for Bushfire attack levels of Flame Zone (FZ) classification or less.
- ▶ **Durability:** Rigid casing protects the intumescent core ensuring service longevity.

### Fixing method

- ▶ The product fits into a groove made in the door frame and/or the edge of the door leaf & is secured using the integral self-adhesive tape.

### Standard lengths

- ▶ 1m and 2.1m.
- ▶ 2.75m available to special order.

### Finishes

- ▶ Standard colours: Black, white & brown.
- ▶ Available in a range of non-standard colours by special order.

# LP1004DS, LP1504DS, LP2004DS + LP3004DS

## MEDIUM DUTY

This acoustic, smoke & fire seal is designed to allow seal continuity at hinge positions. This slim-line seal is fitted into the door edge or timber frame to restrict the spread of ambient & elevated temperature smoke. When exposed to fire conditions, the high performance intumescent core rapidly expands in volume to seal the door perimeter and restrict the passage of fire, toxic gases & hot smoke.



FIRE + SMOKE SEALS

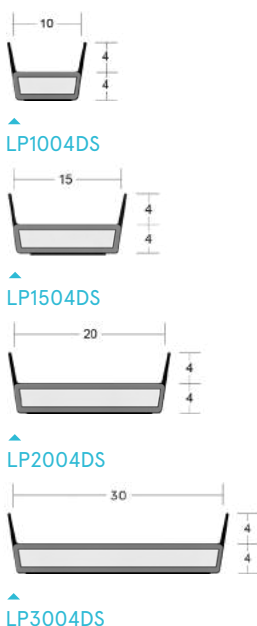

▲ LP1504DS

FIRE SEALS

### SYSTEM SPECIFICATIONS

#### Key benefits

- ▶ All-in-one **"life safety"** seal. Ideal for use in fire engineering solutions to limit the spread of fire and smoke around the edges of doors.
- ▶ May be used to improve fire resistance performance of existing door assemblies.
- ▶ Low friction elastomeric fins provide excellent acoustic and smoke containment performance as well as contributing to low operating forces.
- ▶ Intumescent core protected by a durable thermoplastic sheath.
- ▶ Suitable for healthcare applications, the casing and fins feature anti-microbial additives to limit bacterial growth.
- ▶ Use in conjunction with a LAS8001 si drop seal for complete **"life safety door"** sealing solution.

#### Approvals

- ▶ **Fire:** Tested in accordance with AS1530.4 on proprietary AS1905.1 fire door assemblies for up to 4 hour rating.
- ▶ **Sound:** Acoustically tested in accordance with ISO10140-2 and AS/NZS717.1 with ratings up to 35Rw on appropriate rated assemblies.
- ▶ **Durability:** Tested for reliability, seals completed 100,000 cycles without failure.

#### Gap sizes

- ▶ 2.5mm - 3mm.

#### Fixing method

- ▶ The product fits into a groove made in the door frame and/or the edge of the door leaf & is secured using the integral self-adhesive tape.

#### Standard lengths

- ▶ 1m and 2.1m.
- ▶ Other lengths available to special order.

#### Finishes

- ▶ Standard colour: Black with black fins.
- ▶ Available in a range of other colours.

## DROP SEALS

# LAS8001 si HSS

## HEAVY DUTY

This fully mortised aluminium automatic drop seal features a silicone rubber gasket with intumescent core and internal fins. It is used to close the gap under single swing doors to maintain their acoustic, smoke and energy efficiency performance. The seal incorporates a high efficiency spring loaded mechanism that extends the seal as the door swings shut and automatically retracts it as the door is opened by just a few centimetres.

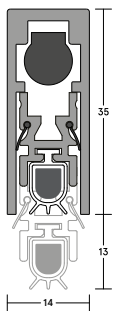
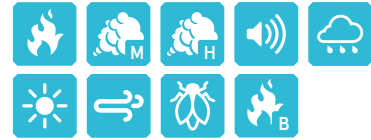

LAS8001 si HSS



LAS8001 si HSS

FIRE + SMOKE SEALS

## SYSTEM SPECIFICATIONS

### Key benefits

- ▶ Effective acoustic sealing solution that is fully concealed in the bottom of the door.
- ▶ Dual internal sealing fins enhance acoustic and smoke containment performance.
- ▶ Supplied with high performance fire rated silicone rubber gasket.
- ▶ Fully automatic, no power connection required.
- ▶ Simple adjustment to suit varying door gap requirements.
- ▶ Proven long term reliability.

### Gap sizes

- ▶ Accommodates & seals gaps up to 13mm.
- ▶ Greater gaps can be sealed if product is used with a threshold plate, please speak to our technical team for more info.

### Fixing method

- ▶ Fits into a 15mm (W) x 35mm (D) groove fixed in place with screw fixed end plates.

### Approvals

- ▶ **Fire:** Tested in accordance with AS1530.4 on proprietary AS1905.1 fire door assemblies for up to 4 hour rating.
- ▶ **Smoke:** Tested in accordance with AS1530.7 on AS6905 compliant door assemblies. Conforms with BCA Specification C3.4 smoke sealing requirements.
- ▶ **Sound:** Acoustically tested in accordance with ISO10140-2 and AS/NZS717.1 with ratings up to 42Rw on appropriate rated assemblies.
- ▶ **Bushfire:** Approved for use on proprietary fire door assemblies for Bushfire attack levels of Flame Zone (FZ) classification or less.
- ▶ **Durability:** Long term mechanical test, completing 100,000 cycles without failure.

### Standard lengths

- ▶ 435mm (may be cut back to 335mm)
- ▶ 535mm (may be cut back to 435mm)
- ▶ 635mm (may be cut back to 535mm)
- ▶ 735mm (may be cut back to 635mm)
- ▶ 820mm (may be cut back to 735mm)
- ▶ 920mm (may be cut back to 820mm)
- ▶ 1070mm (may be cut back to 920mm)
- ▶ 1220mm (may be cut back to 1070mm)
- ▶ 1400mm\* (may be cut back to 1220mm)
- ▶ 1600mm\* (may be cut back to 1400mm)

\*Non-standard sizes do not hold test evidence for the approval for use. Speak to our Technical Team for advice.

### Finishes

- ▶ Silver anodised aluminium with stainless steel end plates and grey silicone rubber gasket.

## DROP SEALS

# LAS8002 si HSS

## MEDIUM DUTY

This face-fixed (or semi-mortised) aluminium automatic drop seal features a silicone rubber gasket with intumescent core and internal fins. It is used to close the gap under single swing doors to maintain their acoustic, smoke and energy efficiency performance. The seal incorporates a high efficiency spring loaded mechanism that extends the seal as the door swings shut and automatically retracts it as the door is opened by just a few centimetres.

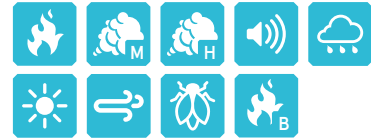

FIRE + SMOKE SEALS

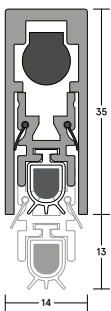

LAS8002 si HSS



LAS8002 si HSS

## SYSTEM SPECIFICATIONS

### Key benefits

- ▶ Effective acoustic sealing solution that can easily be retrofitted to existing door assemblies.
- ▶ Dual internal sealing fins enhance acoustic and smoke containment performance.
- ▶ Quickly and easily fitted to the bottom of door.
- ▶ Can be fitted semi-mortised for a flush finish.
- ▶ Supplied with a fire rated silicone rubber gasket and aesthetic push-fit end caps.
- ▶ Fully automatic, no power connection required.
- ▶ Simple adjustment to suit varying door gap requirements.
- ▶ Proven long term reliability.

### Gap sizes

- ▶ Accommodates & seals gaps up to 13mm.
- ▶ Greater gaps can be sealed if product is used with a threshold plate; speak to our technical team for more info.

### Approvals

- ▶ **Fire:** Tested in accordance with AS1530.4 on proprietary AS1905.1 fire door assemblies for up to 4 hour rating.
  - ▶ **Smoke:** Tested in accordance with AS1530.7 with medium temperature smoke approvals for use on AS6905 compliant smoke door assemblies. Conforms with BCA Specification C3.4 smoke sealing requirements.
  - ▶ **Sound:** Acoustically tested in accordance with ISO10140-2 and AS/NZS717.1 with ratings up to 37Rw on appropriate rated assemblies.
  - ▶ **Bushfire:** Approved for use on proprietary fire door assemblies for Bushfire attack levels of Flame Zone (FZ) classification or less.
  - ▶ **Durability:** Long term mechanical test, completing 100,000 cycles without failure.
- ### Fixing method
- ▶ Face-fixed or semi-mortised to the bottom of the door. Fixing screws are supplied.

### Standard lengths

- ▶ 435mm (may be cut back to 335mm)
- ▶ 535mm (may be cut back to 435mm)
- ▶ 635mm (may be cut back to 535mm)
- ▶ 735mm (may be cut back to 635mm)
- ▶ 820mm (may be cut back to 735mm)
- ▶ 920mm (may be cut back to 820mm)
- ▶ 1070mm (may be cut back to 920mm)
- ▶ 1220mm (may be cut back to 1070mm)
- ▶ 1400mm\* (may be cut back to 1220mm)
- ▶ 1600mm\* (may be cut back to 1400mm)

\*Non-standard sizes do not hold test evidence for the approval for use. Speak to our Technical Team for advice.

### Finishes

- ▶ Silver anodised aluminium with grey push-fit end caps & grey silicone rubber gasket.

## DROP SEALS

# LAS8003 si HSS

## MEDIUM DUTY

This face-fixed or semi-mortised aluminium automatic drop seal features a silicone rubber gasket with intumescent core and internal fins. It is used to close the gap under single swing doors to maintain their acoustic, smoke and energy efficiency performance. The seal incorporates a high efficiency spring loaded mechanism that extends the seal as the door swings shut and automatically retracts it as the door is opened by just a few centimetres.

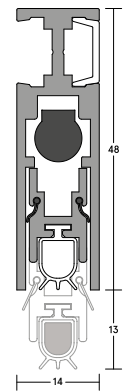

LAS8003 si



LAS8003 si HSS

FIRE + SMOKE SEALS

## SYSTEM SPECIFICATIONS

### Key benefits

- ▶ Effective acoustic sealing solution that can easily be retrofitted to existing door assemblies.
- ▶ Dual internal sealing fins enhance acoustic & smoke containment performance.
- ▶ Fixing points are fully concealed behind a click-fit cover strip.
- ▶ Quick and easy installation.
- ▶ May be fitted semi-mortised for a flush finish.
- ▶ Supplied with a fire rated silicone rubber gasket & colour matched push-fit end caps.
- ▶ Fully automatic, no power connection required.
- ▶ Simple adjustment to suit varying door gap requirements.
- ▶ Proven long term reliability.

### Gap sizes

- ▶ Accommodates & seals gaps up to 13mm.
- ▶ Greater gaps can be sealed if used with a threshold plate.

### Approvals

- ▶ **Fire:** Tested in accordance with AS1530.4 on proprietary AS1905.1 fire door assemblies for up to 4 hour rating.
- ▶ **Smoke:** Medium temperature smoke approvals for use on AS6905 compliant smoke door assemblies. Conforms with BCA Specification C3.4 smoke sealing requirements.
- ▶ **Sound:** Acoustically tested in accordance with ISO10140-2 and AS/NZS717.1 with ratings up to 37Rw on appropriate rated assemblies.
- ▶ **Bushfire:** Approved for use on proprietary fire door assemblies for Bushfire attack levels of Flame Zone (FZ) classification or less.
- ▶ **Durability:** Long term mechanical test, completing 100,000 cycles without failure.

### Fixing method

- ▶ Face-fixed or semi-mortised. Fixing screws are supplied.

### Standard lengths

- ▶ 435mm (may be cut back to 335mm)
- ▶ 535mm (may be cut back to 435mm)
- ▶ 635mm (may be cut back to 535mm)
- ▶ 735mm (may be cut back to 635mm)
- ▶ 820mm (may be cut back to 735mm)
- ▶ 920mm (may be cut back to 820mm)
- ▶ 1070mm (may be cut back to 920mm)
- ▶ 1220mm (may be cut back to 1070mm)
- ▶ 1400mm\* (may be cut back to 1220mm)
- ▶ 1600mm\* (may be cut back to 1400mm)

\*Non-standard sizes do not hold test evidence for the approval for use. Speak to our Technical Team for advice.

### Finishes

- ▶ Silver anodised aluminium, stainless steel end plates & grey silicone rubber gasket.

# DOOR UPGRADE SOLUTIONS

Retro-fit door bottom and perimeter upgrade sealing solutions are used to salvage existing fire door assemblies that have clearances exceeding those specified in Australian fire door standard AS1905.1.

Simple to use and easy to fit; they provide a viable alternative to costly fire door replacements.



# LDBU

## HEAVY DUTY

This retro-fit seal is used to upgrade fire door assemblies that have a door bottom clearance that exceeds the 10mm specified in AS1905.1

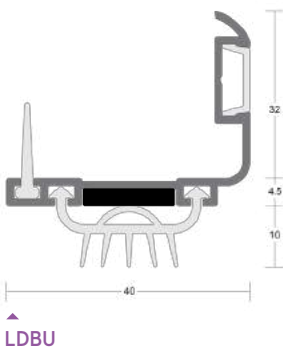

DOOR UPGRADE SOLUTIONS

### SYSTEM SPECIFICATIONS

#### Key benefits

- ▶ Simple screw fix installation.
- ▶ Suitable for upgrading door bottom gaps up to \*24mm. Cost savings for building owners as non-compliant fire door assemblies may be simply salvaged rather than replaced.
- ▶ Incorporates a waterproof high performance graphite strip suitable for exterior applications.
- ▶ Durable silicone rubber gaskets.

#### Gap size

- ▶ Up to 24mm\* maximum.
- ▶ \*Please refer to our technical brochure "Retro-fit Sealing Solutions for Non-compliant Fire Door Assemblies" regarding maximum allowable gap sizes.

#### Approvals

- ▶ **Fire:** Tested in accordance with AS1530.4 on proprietary AS1905.1 fire door assemblies for up to 4 hour rating.
- ▶ **Bushfire:** Approved for use on proprietary fire door assemblies for Bushfire attack levels of Flame Zone (FZ) classification or less.

#### Fixing method

- ▶ Self-tapping screws are supplied.
- ▶ Fixing holes are pre-drilled and slotted to allow the seals to be adjusted and positioned accurately. A snap-fit cover strip to conceal fixings is supplied.

#### Standard lengths

- ▶ 820mm, 920mm, 1070mm and 1220mm.

#### Finishes

- ▶ Silver anodised aluminium with grey cover strip and grey silicone rubber blade.



# LDPU

## MEDIUM DUTY

This slim high performance intumescent fire seal is used to upgrade fire door assemblies that have perimeter clearances exceeding the 3mm specified in AS1905.1. When exposed to elevated temperatures, the intumescent core rapidly expands in volume to restrict the passage of fire, hot smoke and toxic gases.

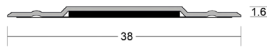

LDPU



LDPU

### SYSTEM SPECIFICATIONS

#### Key benefits

- ▶ Simple peel-and-stick installation.
- ▶ Suitable for upgrading perimeter clearances up to \*8.7mm. Cost savings for building owners as non-compliant fire door assemblies may be simply salvaged rather than replaced. Ideal for use in fire engineering solutions to limit the spread of hot gases around the edges of doors.
- ▶ Incorporates anti-microbial additives as standard.

#### Gap sizes

- ▶ 2mm - 8.7mm.
- ▶ Please refer to our technical brochure "Retro-fit Sealing Solutions for Non-compliant Fire Door Assemblies" regarding maximum allowable gap sizes.

#### Approvals

- ▶ **Fire:** Tested in accordance with AS1530.4 on proprietary AS1905.1 fire door assemblies for up to 4 hour rating.
  - ▶ **Bushfire:** Approved for use on proprietary fire door assemblies for Bushfire attack levels of Flame Zone (FZ) classification or less.
- Fixing method**
- ▶ Aggressive film backed self-adhesive.

#### Standard lengths

- ▶ 1m, 2.1m and 2.75m.
- ▶ Single doorset (SDS): (1 x 1m, 2 x 2.1m).
- ▶ Long Single doorset (LSDS): (1 x 1m, 2 x 2.75m).
- ▶ Double doorset (DDS): (3 x 2.1m).
- ▶ Long double doorset (LDDS): (1 x 2.1m, 2 x 2.75m).

#### Finishes

- ▶ White as standard.

# FIRE RATED AIR TRANSFER GRILLE

Our intumescent air transfer grilles combine air movement with fire protection. Designed to be fitted into doors, walls, ducts, floors + ceilings; they provide a cost effective solution in allowing free air movement and yet maintain the integrity of the floor or ceiling in a fire situation.



## INTUMESCENT FIRE DAMPERS

# LVH

## HEAVY DUTY FIRE RATED AIR TRANSFER GRILLE

Heavy duty intumescent air transfer grille designed for use in fire door assemblies where air transfer or additional ventilation is required.



FIRE RATED AIR TRANSFER GRILLE

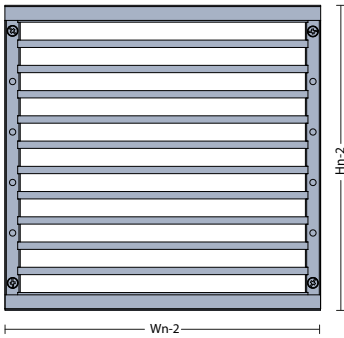

LVH



LVH



LVH with cover grille

### SYSTEM SPECIFICATIONS

#### Key benefits

- ▶ Allows free airflow at ambient conditions.
- ▶ When exposed to fire or elevated temperatures the intumescent slats swell to create a physical barrier that provides up to 240 minutes resistance.

#### Application

- ▶ Please note: Suitable for interior use; if used in an external application, a suitable weather coating should be applied.
- ▶ Visit [lorient.com.au](http://lorient.com.au) for approved fire door types and installation details.

#### Approvals

- ▶ **Fire:** Tested in accordance with AS1530.4 and approved for use on major AS1905.1 proprietary fire door types for up to 4 hours fire resistance.

#### Standard sizes

- ▶ 300mm x 300mm.
- ▶ 450mm x 450mm.
- ▶ 600mm x 300mm.
- ▶ 600mm x 600mm.
- ▶ Supplied as complete kits including two steel cover grilles, fixings and a tube of Lorient intumescent sealant.

#### Fixing

- ▶ Perimeter caulked with Lorient intumescent sealant and sandwiched between the supplied steel cover grilles.

#### Material

- ▶ Z275 galvanised steel.
- ▶ Metal slats with an intumescent core.

#### Finish

- ▶ Silver as standard.

# AURA<sup>®</sup>

# Introducing

## AURA®

### The Design Edge

The AURA® range embraces a discerning selection of perimeter seals, door bottom seals, threshold plates and ramps - all with strong design accents.

Every detail of the AURA® product range is considered and designed to integrate more successfully into beautifully designed doorsets and floors. A number of signature design details feature within the AURA® range; including a distinctive curved profile, which not only creates a sophisticated visual aesthetic, but also spreads and diffuses sound.

AURA® threshold plates and ramps incorporate hardwearing tread strips which deliver greater grip under foot. The unique reversible design provides either a smooth or ridged surface, depending on practical and aesthetic preferences. Wherever possible, AURA® fixings are completely concealed, enhancing the overall finish, preserving clean lines and curves, while also improving security and safety.

All products are manufactured to Lorient's exacting standards. AURA® perimeter seals and drop seals have been successfully tested for acoustic and smoke containment.

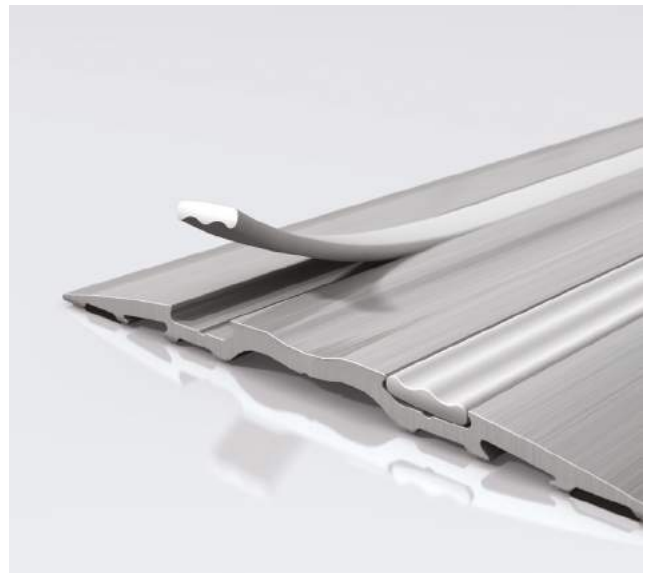
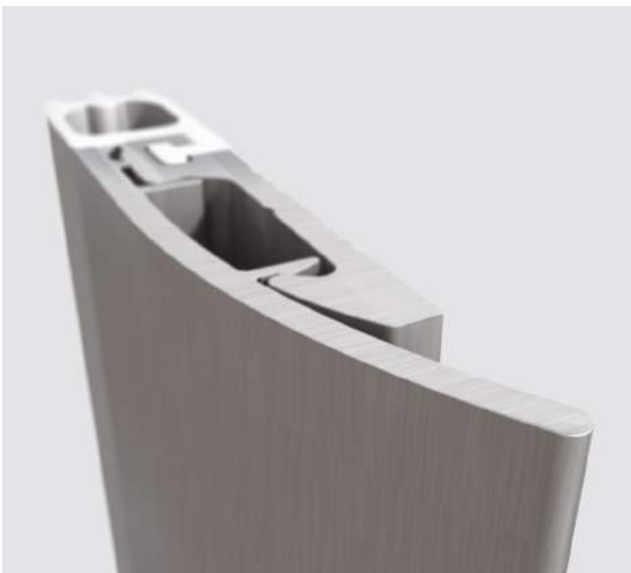

# AAS 4551



## THRESHOLD RAMP

For use in buildings where wheelchairs and trolleys are used, or to compensate for uneven floors. Reversible tread strips provide greater traction. Unique ‘scoops’ further enhance grip for foot or wheeled traffic.

### MEDIUM DUTY



### TECHNICAL

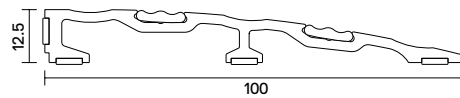

AAS4551 ↑

#### Location

Single and double swing doors.

#### Seal Material

Aluminium with two flexible tread strips.

#### Standard Lengths

- 1m and 2.1m.
- Other lengths available for special order.

#### Fixing

- Pre-drilled & countersunk.
- Fixing screws supplied.
- Tread strips supplied and push-fit into plate to conceal fixings.

#### Finishes

- Silver anodised aluminium with silver tread strips.
- Decorative finishes for threshold plate and different colour tread strips available on request.

AAS4551 ↓



### PERFORMANCE

#### Fire

Approved for use on proprietary AS1905.1 fire doors for up to 4 hours.



# AAS 4552

AURA® ARCHITECTURAL SEALS

## THRESHOLD RAMP

For use in buildings where wheelchairs and trolleys are used, or to compensate for uneven floors. Reversible tread strips provide greater traction. Unique ‘scoops’ further enhance grip for foot or wheeled traffic.

### MEDIUM DUTY



AAS4552 ↓



## TECHNICAL

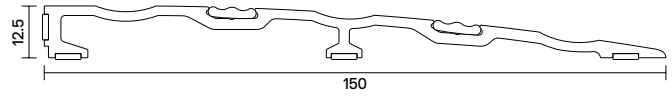

AAS4552 ↑

### Location

Single and double swing doors.

### Seal Material

Aluminium with two flexible tread strips.

### Standard Lengths

- 1m and 2.1m.
- Other lengths available for special order.

### Fixing

- Pre-drilled & countersunk.
- Fixing screws supplied.
- Tread strips supplied and push-fit into plate to conceal fixings.

### Finishes

- Silver anodised aluminium with silver tread strips.
- Decorative finishes for threshold plate and different colour tread strips available on request.

## PERFORMANCE

### Fire

Approved for use on proprietary AS1905.1 fire doors for up to 4 hours.



# AAS 4553



## THRESHOLD RAMP

For use where wheelchairs and trolleys are used or to compensate for uneven floors. Reversible tread strips offer greater friction underfoot. Unique ‘scoops’ further enhance grip for foot or wheeled traffic.

### MEDIUM DUTY



### TECHNICAL

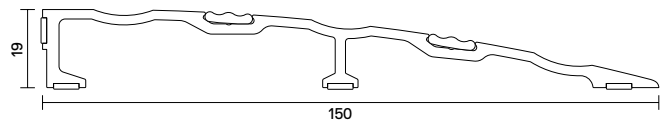

AAS4553 ↑

#### Location

Single and double swing doors.

#### Seal Material

Aluminium with two flexible tread strips.

#### Standard Lengths

- 1m and 2.1m.
- Other lengths available for special order.

#### Fixing

- Pre-drilled & countersunk.
- Fixing screws supplied.
- Tread strips supplied and push-fit into plate to conceal fixings.

#### Finishes

- Silver anodised aluminium with silver tread strips.
- Decorative finishes for threshold plate and different colour tread strips available on request.

AAS4553 ↓



### PERFORMANCE

#### Fire

Approved for use on proprietary AS1905.1 fire doors for up to 4 hours.



# AAS 7501

AURA® ARCHITECTURAL SEALS

## PERIMETER SEAL

A stylish perimeter seal with square cover plate ideal for butt-jointing or mitring. Proven performance for acoustic containment. The decorative cover plate completely conceals fixings.

### MEDIUM DUTY



AAS7501 ↓

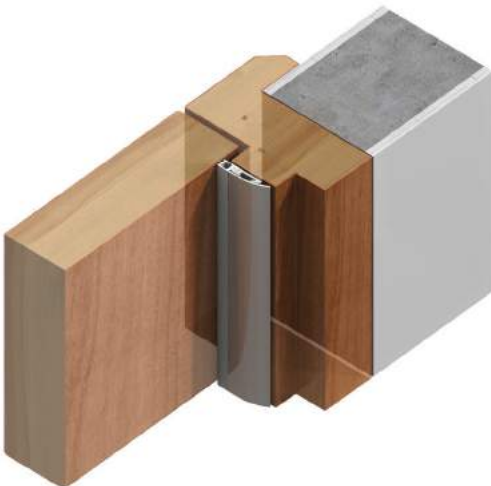

## TECHNICAL

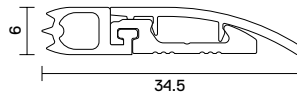

AAS7501 ↑

### Location

Head and jambs of single swing doors.

### Seal Material

Silicone rubber.

### Fixing

- Fixing holes pre-drilled and slotted for positional accuracy.
- Screw pack supplied.

### Finishes

- Silver anodised aluminium with grey silicone gasket.

### Standard Lengths

- 1m, 2.1m and 2.75m.
- Doorset packs:
  - Single doorset (SDS): (1 x 1m, 2 x 2.1m).
  - Long single doorset (LSDS): (1 x 1m, 2 x 2.7m).
  - Double doorset (DDS): (3 x 2.1m).
  - Long double doorset (LDDS): (1 x 2.1m, 2 x 2.75m).
- Other lengths available for special order.

## PERFORMANCE

### Fire

Approved for use on proprietary AS1905.1 fire doors for up to 4 hour fire rating.

### Acoustic

ISO 10140-2 & AS/NZS ISO717.1.

### Bushfire

Approved for use on proprietary fire door assemblies for Bushfire attack levels of Flame Zone (FZ) classification or less.

### Weighted Sound Reduction Index

39 dB.  
(AAS7501 & AAS8501 on a proprietary acoustic door).

### Durability

100,000 cycles on full-size door assemblies.

# AAS 7503



## PERIMETER SEAL

A stylish perimeter seal with square cover plate ideal for butt-jointing or mitring. Proven performance for acoustic containment. The decorative cover plate completely conceals fixings.

### MEDIUM DUTY



## TECHNICAL

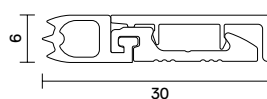

AAS7503 ↑

### Location

Head and jambs of single swing doors.

### Seal Material

Silicone rubber

### Fixing

- Fixing holes pre-drilled and slotted for positional accuracy.
- Screw pack supplied.

### Finishes

- Silver anodised aluminium with grey silicone gasket.
- Decorative finishes available.

### Standard Lengths

- 1m, 2.1m and 2.75m.
- Doorset packs:
  - Single doorset (SDS): (1 x 1m, 2 x 2.1m).
  - Long Single doorset (LSDS): (1 x 1m, 2 x 2.7m).
  - Double doorset (DDS): (3 x 2.1m).
  - Long double doorset (LDDS): (1 x 2.1m, 2 x 2.75m).
- Other lengths available for special order.

AAS7503 ↓

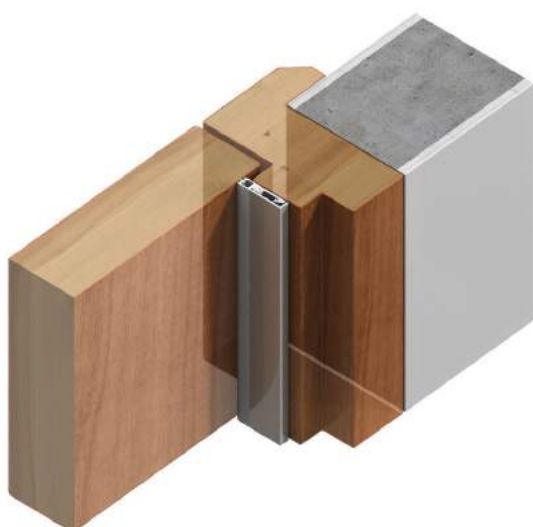

## PERFORMANCE

### Fire

Approved for use on proprietary AS1905.1 fire doors for up to 4 hour fire rating.

### Acoustic

ISO 10140-2 & AS/NZS ISO717.1.

### Bushfire

Approved for use on proprietary fire door assemblies for Bushfire attack levels of Flame Zone (FZ) classification or less.

### Weighted Sound Reduction Index

39 dB (AAS7501 & AAS8501 on a proprietary acoustic door).

### Durability

100,000 cycles on full-size door assemblies.



# AAS 7506

AURA® ARCHITECTURAL SEALS

## PERIMETER SEAL

A robust seal designed for use on plain or rebated meeting stiles. With proven acoustic performance it is also suitable for smoke, light, and draught containment. The leg can be cut out to make way for locks and latches.

### MEDIUM DUTY



AAS7506 ↓



## TECHNICAL

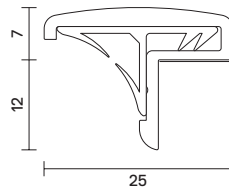

AAS7506 ↑

### Location

Meeting stiles of single action double leaf doors - where only one door leaf is in use.

### Seal Material

Co-extruded elastomeric with flexible curved fins.

### Standard Lengths

- 2.25m, 2.75m and 3m.

### Fixing

- Fixing holes pre-drilled and countersunk.
- Screw pack provided.
- Using self-adhesive tape to position aluminium carrier while fixing, push-fit Batwing® seal into place.

Note: A door selector should be considered unless one leaf is intended to be fixed.

### Finishes

- Silver anodised aluminium with grey gasket.
- Other colours available.

## PERFORMANCE

### Acoustic

ISO 10140-2 & AS/NZS ISO717.1.

### Weighted Sound Reduction Index

35 dB.  
(AAS7506 & AAS8501 on a proprietary acoustic door).

### Smoke Leakage

BCA Specification C3.4 smoke sealing requirements.

# FINISHES INFORMATION

**Our wide range of colours and finishes provides inspiration for all types of buildings; from luxurious and contemporary hotels, to bright and bold nurseries and schools – there's a perfect colour or finish available to suit every project.**

We have a number of stylish finishes for our range of high performance architectural seals, which are available in silver anodised aluminium as standard. Our finishes are designed to provide creative freedom for the most discerning interiors; and include a beautiful bronze; and a sophisticated, sleek, matte black. Please ask for bespoke project pricing and lead times on these specials.

An in-house, RAL colour matching service is also available for those wishing to coordinate seals with other architectural features, such as door furniture and trims. Special colours are created using a powder coated finish for a higher aesthetic or to complement bespoke interiors. All architectural seals are manufactured in Lorient's UK facility, to exacting standards and have been designed and developed to deliver the perfect combination of stylish looks and outstanding performance.

We extend our offering way beyond colour and finishes – specialising in assisting and developing customised solutions through collaboration with our customers. Utilising in-house expertise, custom-made products are created to suit customers' requirements.



# ADDITIONAL INFORMATION

## FITTING INSTRUCTIONS

Comprehensive fitting instructions are included with each consignment; and are also available to download from our website [www.lorient.com.au](http://www.lorient.com.au)

## MAINTENANCE

Periodic inspection and cleaning is recommended for all types of seals. The appearance and performance of seals will benefit from an annual wipe with a damp cloth. Seals should be checked for correct adjustment. Worn or damaged seals should be replaced immediately.

## COMPATIBILITY

All Lorient Architectural Seals are compatible with the materials normally used in doors and door frames, including wood, steel, PVC, aluminium and glass.

Please Note: Recommendations as to methods, use of materials and construction details are based on the experience and knowledge of Lorient and are given in good faith as a general guide and a service to designers, contractors and manufacturers.

## GUARANTEE OF ORIGIN

Each production batch of Lorient seals is laser engraved unobtrusively on the edge of the profile with the Lorient name and a code reference. This ensures the product and details of its production can be traced should the need arise.

**Unidentifiable substitute products should never be accepted.**

# COMPREHENSIVE SUPPORT

We continue to lead the way in Research + Development. As a company we have over 40 years' experience, so our experts are well equipped to listen, help and advise you on your sealing system requirements.

## Technical Services

We're happy to provide specialist advice on acoustic, smoke and fire protection for refurbishment and new build projects. If you need assistance, you can call our Technical Services team.

Alternatively, we can arrange a site visit to get a clearer idea of your needs and how we can help you. We also provide copies of test reports and samples where needed; and can give guidance on how best to meet Building Regulations and Standards.

## Web Support

Our website features a comprehensive range of supporting documents covering the entire range of products, including installation guides and CAD drawings. All of our brochures and products sheets are also available for download, together with copies of certification and specification texts.

## Online Acoustic Search tool

Our Acoustic Search tool on our website gives you quick and easy access to a wide range of tested acoustic sealing systems on a variety of popular door constructions & configurations.

[www.lorientuk.com/acousticsearch](http://www.lorientuk.com/acousticsearch)

The tool allows users to select a specific decibel rating; along with door configuration, fire door rating, doorset type etc to filter the results. The 'Acoustic Search' tool is updated frequently with Lorient's ever-expanding portfolio of test evidence. If you're looking for high performance or specialist applications – please contact us on +61 (0)3 8574 3888, there may be some additional configurations we haven't yet published.



## Customisation

If you have a particular requirement which isn't covered by the applications in this brochure, we may be able to supply an existing non-standard item, or even develop a customised solution for you. Utilising in-house expertise, bespoke products are created to your requirements; from a functional or aesthetic perspective, or both.

Lorient's dedicated Technical Services team supports and works as part of your design team, offering informed product advice and guidance on regulatory requirements and standards.



**Call our Technical  
Services team**  
+61 (0)3 8574 3888

[www.lorient.com.au](http://www.lorient.com.au)



# TESTING + TECHNICAL SERVICES

We've built our reputation on the quality and dependability of our products, and our investment in R+D has played a pivotal role in keeping our products at the forefront of our industry. Our dedicated Testing and Technical Services division has established itself as an important facility for manufacturers and designers of doors, windows, glazing systems and hardware, to name just a few.

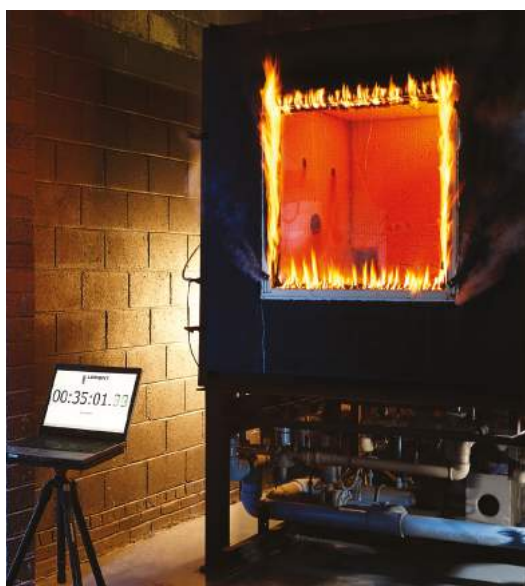

Alongside full-scale acoustic testing, we are also able to offer:

- ▶ Fire testing (indicative)
- ▶ Smoke leakage
- ▶ Air leakage
- ▶ Mechanical cycling
- ▶ Environmental chamber analysis
- ▶ Site-based testing
- ▶ Attendance at external fire tests
- ▶ Consultancy services
- ▶ Fire door inspection services

Call our Technical Services team  
+61 (0)3 8574 3888



# CPDs

We offer fully-accredited CPD seminars. Impartially presented by knowledgeable speakers, the seminars are structured to be technically informative, and provide practical advice.



## Performance Door Design: The Basics of Sound Reduction

Effective acoustic containment helps to improve the quality of the built environment, preserving privacy as well as excluding unwanted noise. With changing regulations, it's essential to be informed of the relevant requirements and the implications for door assemblies.

### Our acoustic CPD seminar covers:

- ▶ The nature of sound, examining airborne transmission of sound;
- ▶ Regulatory requirements and British Standards that relate to acoustic performance;
- ▶ Test procedures and interpretation of test reports;
- ▶ Effective design of door assemblies for acoustic performance, including door construction and the influence of sealing systems;
- ▶ Design conflicts between acoustic performance, durability and ease of operation of the door;
- ▶ Independent accreditation.

## The Role and Performance of Fire and Smoke-Resisting Door Assemblies

The importance of fire and smoke resisting door assemblies is illustrated in this CPD seminar, covering:

- ▶ Hard facts concerning deaths, injuries and property damage caused by fire and smoke;
- ▶ Regulatory requirements for fire and smoke resisting door assemblies;
- ▶ The nature and behaviour of smoke;
- ▶ Effective design of door assemblies for smoke containment, including the threshold gap;
- ▶ Design conflicts between fire containment, smoke containment, durability and ease of operation of the door;
- ▶ Independent accreditation.

Our CPD materials have been independently verified and certified by the RIBA as CPD approved. A certificate for 1 hour's CPD will be provided, which contributes to Continuing Professional Development requirements.

All of our CPD seminars are available to view virtually, please speak to our Marketing Department for further information: [mktg@lorientuk.com](mailto:mktg@lorientuk.com).

# NEW AIR TRANSFER GRILLE CPD WEBINAR

Our latest webinar is entitled: **The Specification + Design of Air Transfer Grilles / Dampers.**

This is a fantastic new addition to our growing collection of CPD seminars and explores:

- ▶ The latest test standards and building regulations;
- ▶ The major difference between intumescent air transfer grilles and dampers;
- ▶ The importance of correct specification, installation and maintenance;
- ▶ Plus it offers practical solutions to fire and smoke containment over a range of applications.

All of our CPD seminars are available to view virtually, please speak to our Marketing Department for further information: [mktg@lorientuk.com](mailto:mktg@lorientuk.com).





**AUSTRALIA**

T: +61 (0)3 8574 3888  
E: customerservice.au@assaabloy.com

**SINGAPORE**

T: +65 6270 1279  
E: sales@lorient.com.sg

**UK / EUROPE**

T: +44 (0)1626 834252  
E: sales@lorientuk.com

**UAE**

T: +9714 883 7206  
E: sales@lorientgulf.ae

**HONG KONG**

T: +852 2260 0888  
E: sales@lorienthk.com

**USA**

T: +1 859 252 7441  
E: inquiries@lorientna.com

For further information about  
Lorient products please visit:  
[www.lorientgroup.com](http://www.lorientgroup.com)



@LorientUK



/company/lorient



@lorientuk



/LorientPolyproducts

**ASSA ABLOY**

An ASSA ABLOY Group Brand